

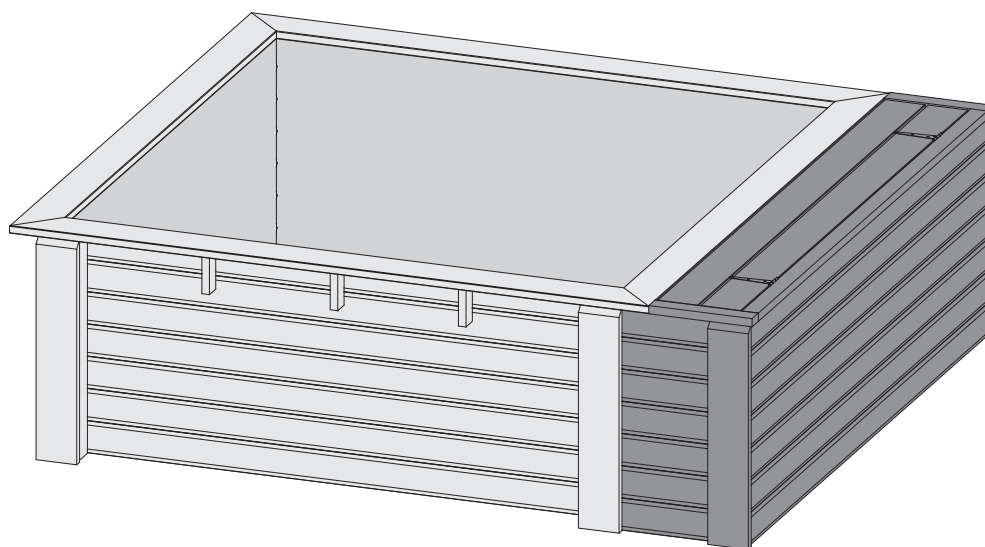

13040-tb - Anbauschacht zu Trend Holzpool | Minipool | Rechteck

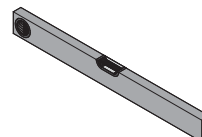

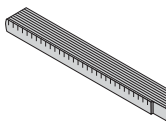
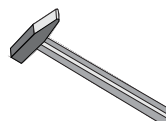
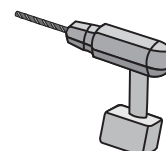
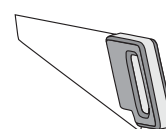

-  **Aufbauanleitung**
-  **Building Instructions**
-  **notice de montage**
-  **montagehandleiding**
-  **Montagevejledning**
-  **Instrucciones de construcción**
-  **Istruzioni per il montaggio**
-  **Montážní návod**





 Vergleichen Sie zuerst die Material-liste mit Ihrem Paketinhalt! Bitte haben Sie Verständnis, dass Beanstandungen nur im nicht aufgebauten Zustand bearbeitet werden können!

 Vergelijk eerst de lijst van materialen met de inhoud van uw pakket! Reclamaties kunnen alleen in behandeling worden genomen zolang de onderdelen nog niet zijn gemonteerd!

 Confrontate questa distinta materiali prima con il contenuto del pacchetto! Vi preghiamo di comprendere che eventuali reclami possono essere accolti solo prima del montaggio!

 First compare the list of materials with your package contents! Please understand that complaints can be processed in the non-built status only!

 Start med at kontrollere materialelisten med indholdet af den leverede pakke! Vi gør venligst opmærksom på at reklamationer kun kan behandles for materialer som ikke er blevet bearbejdet!

 Nejprve překontrolujte obsah balení podle materiálového listu! Mějte pochopení pro to, že případnou reklamaci se můžeme zabývat pouze tehdy, když díly nebudou smontované! Za pomoci tohoto seznamu můžete jednotlivé díly přiřadit k montážnímu návodu.

 Commencez par comparer la liste du matériel avec le contenu de votre paquet! Sachez que nous traitons uniquement les réclamations concernant le matériel à l'état non monté!

 En primer lugar, compare la lista de material con el contenido del paquete. Rogamos entienda que las reclamaciones sólo pueden ser tramitadas antes de montar el objeto!

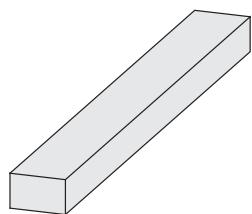
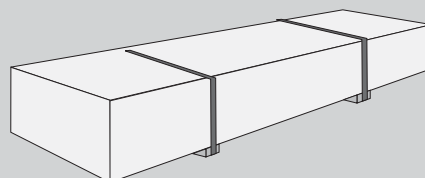
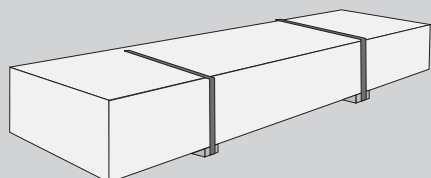

4 x A1	140 x 58 x 28 mm	ID 23729
4 x A2	286 x 58 x 28 mm	ID 23733
2 x A3	356 x 58 x 28 mm	ID 23728
4 x A4	407 x 58 x 28 mm	ID 23730
6 x A5	756 x 58 x 28 mm	ID 13933
1 x A6	2085 x 58 x 28 mm	ID 23727

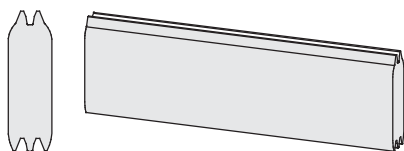

12 x B1	407 x 121 x 38 mm	ID 22317
6 x B2	2177 x 121 x 38 mm	ID 22316

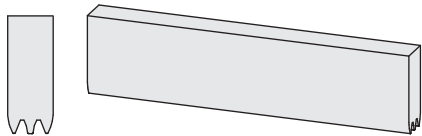

2 x B3	407 x 96 x 38 mm	ID 22318
1 x B4	2177 x 96 x 38 mm	ID 22315

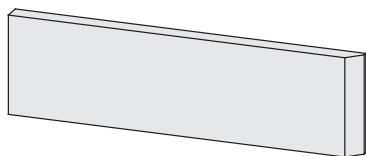

2 x C1	756 x 140 x 26 mm	ID 22346
--------	-------------------	----------

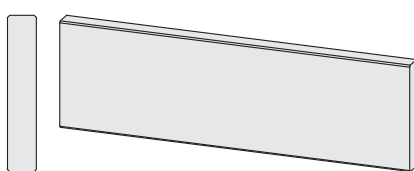

4 x F1	140 x 140 x 26 mm	ID 23726
1 x F2	2069 x 140 x 26 mm	ID 23725

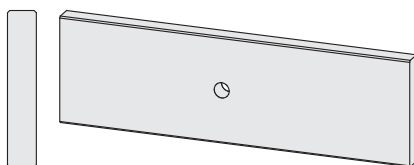

2 x F3	2069 x 140 x 26 mm	ID 26531
--------	--------------------	----------

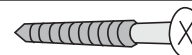

15 x	4 x 25mm	ID 5841
65 x	4 x 35 mm	ID 39398
85 x	4 x 50 mm	ID 39399
10 x	6 x 60 mm	ID 14014
30 x	6 x 80 mm	ID 39397



30 x	6 x 50 mm	
------	-----------	--

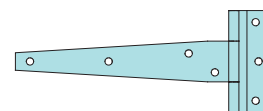







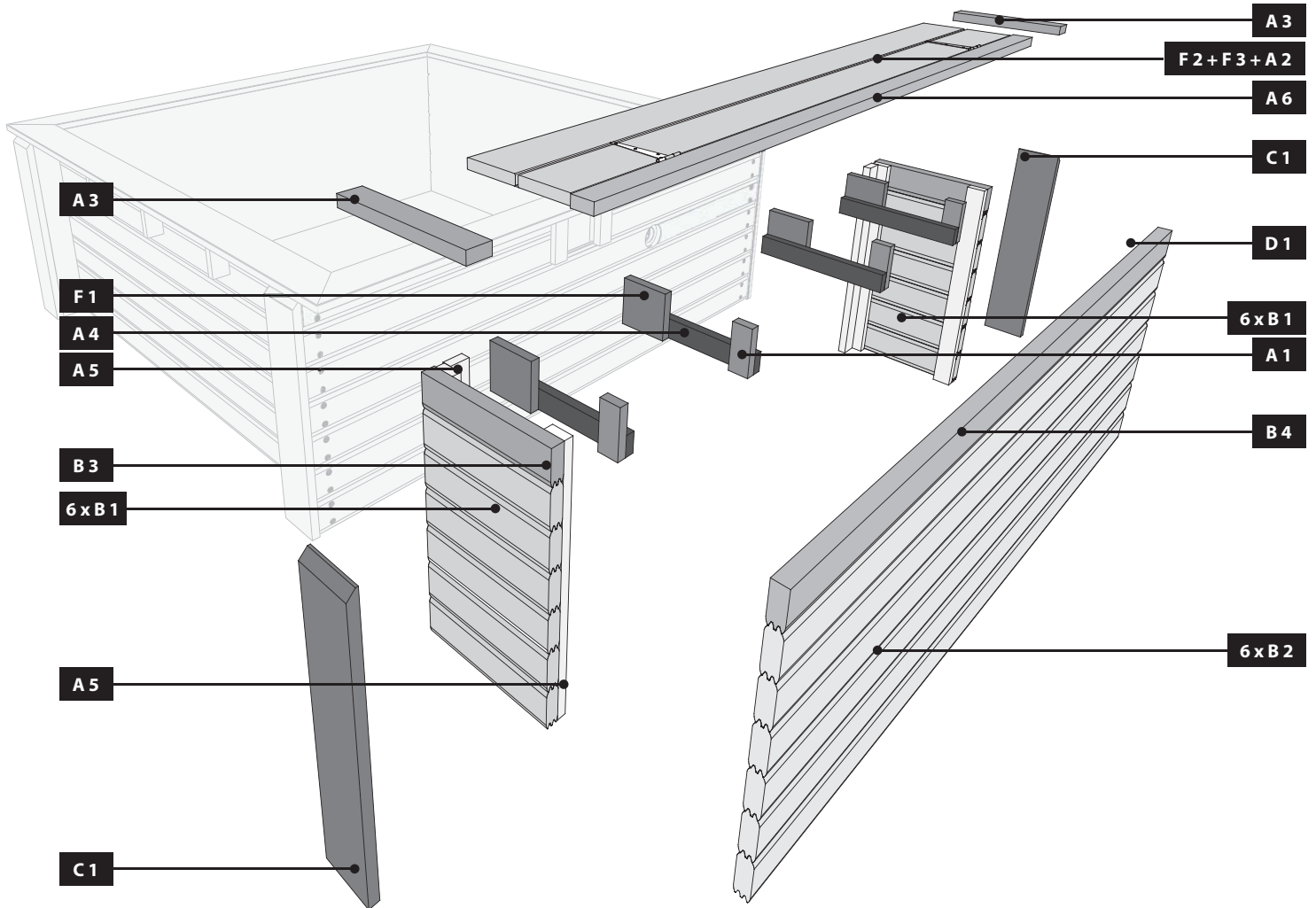

2 x		ID 42773
-----	--	----------

Übersicht
Overview
enquête

overzicht
undersøgelse
estudio

sondaggio
přehled



-  Skimmer in Hauptwindrichtung einbauen
-  installeren skimmers in de belangrijkste windrichting
-  installing skimmers in the main wind direction
-  l'installation de récupérateurs dans la direction principale du vent
-  la instalación de skimmers en la dirección dominante del viento
-  installazione skimmer nella direzione principale del vento
-  instalaci sběračky v hlavním směru větru
-  Installer skimmer i hovedvindretningen

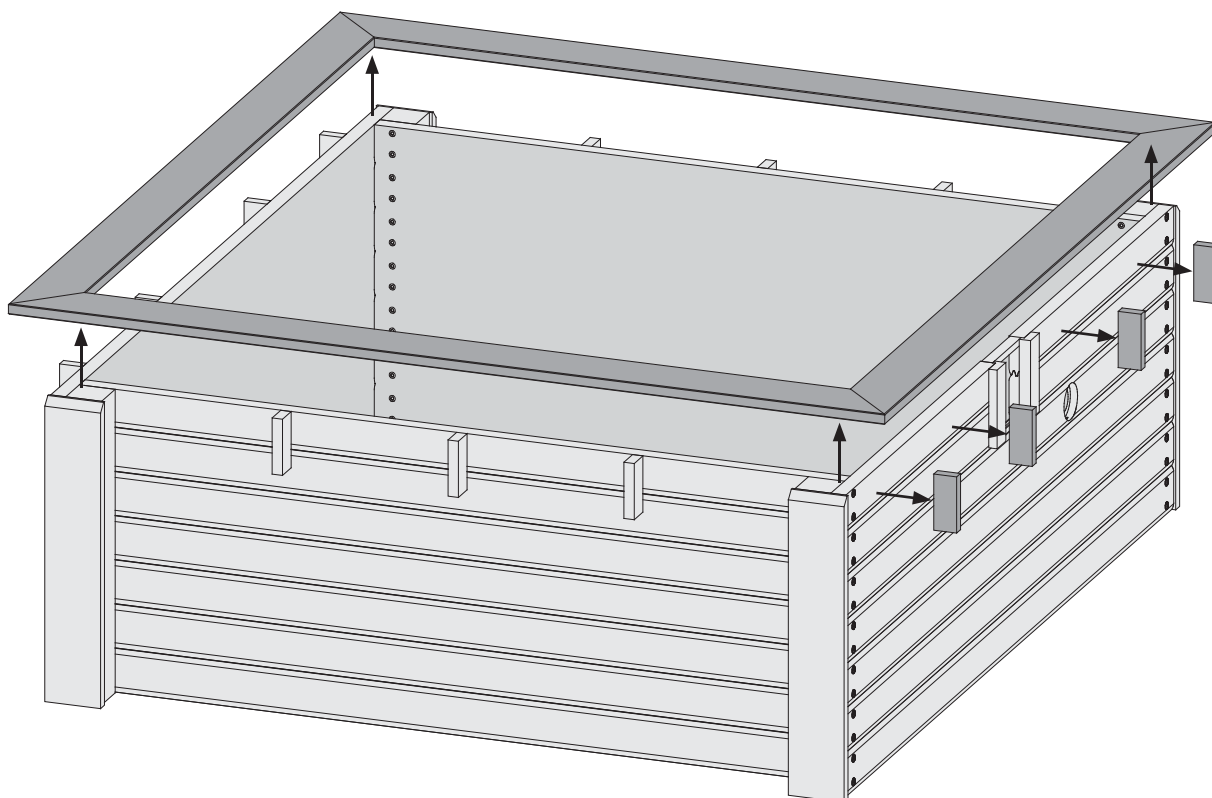
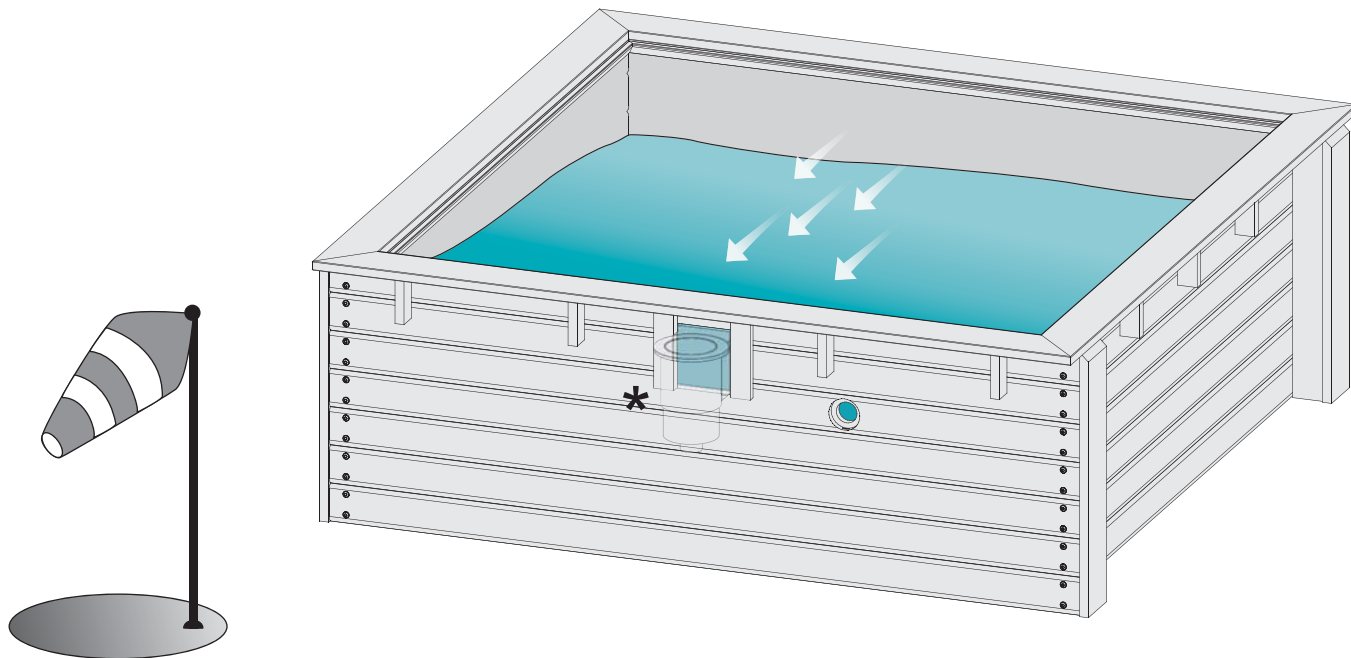



Ø5 mm 6x80

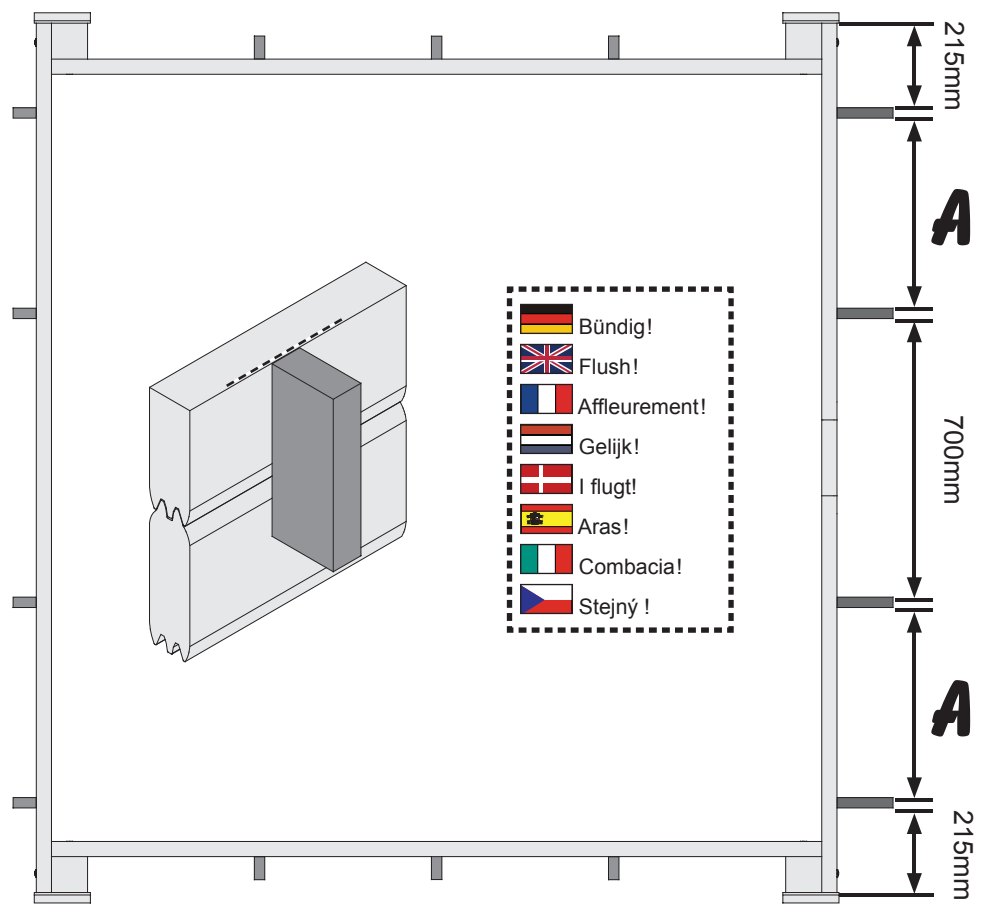
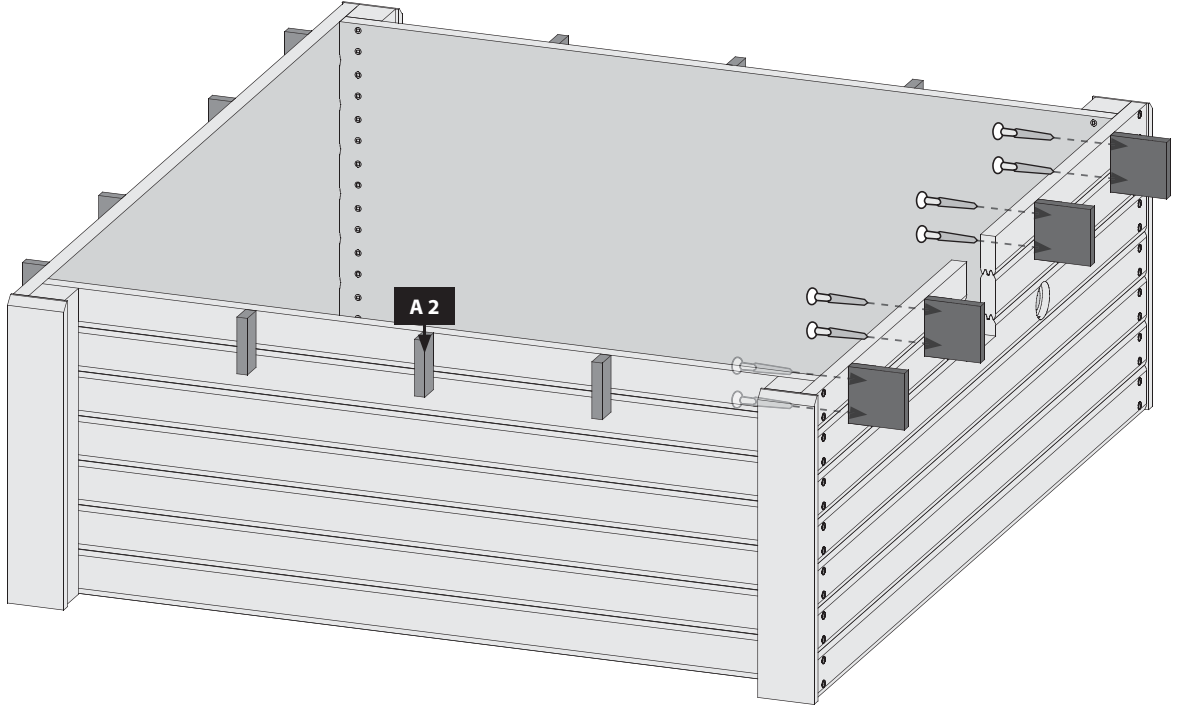
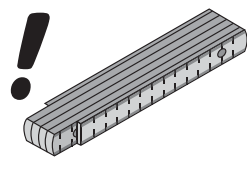

-  Draufsicht
-  Top view
-  vue de dessus
-  bovenaanzicht
-  vista desde arriba
-  vista desde arriba
-  vista dall'alto
-  pŕodorys

-  Bündig!
-  Flush!
-  Affleurement!
-  Gelijk!
-  I flugt!
-  Aras!
-  Combacia!
-  Stejný !

02

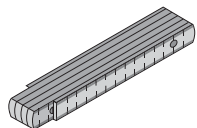

Ø3 mm 4x50

8x

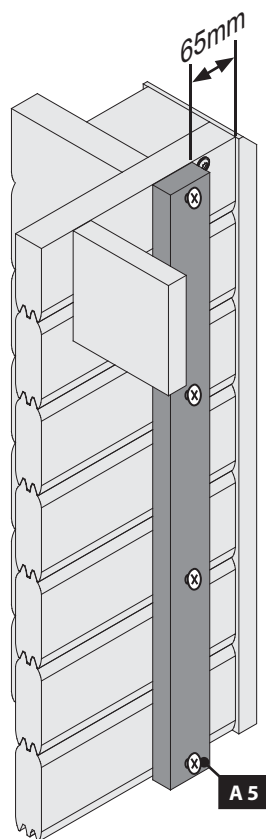
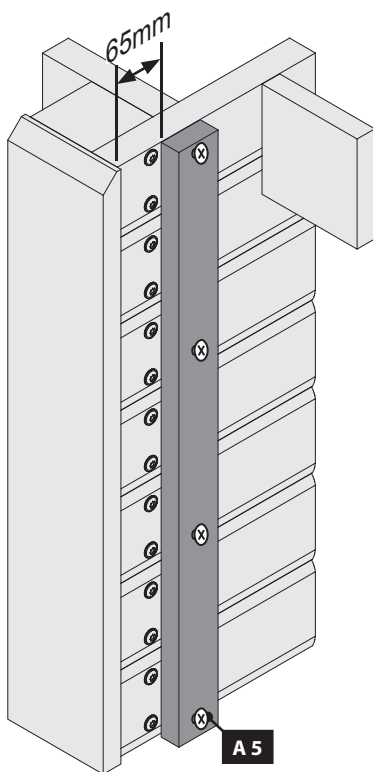
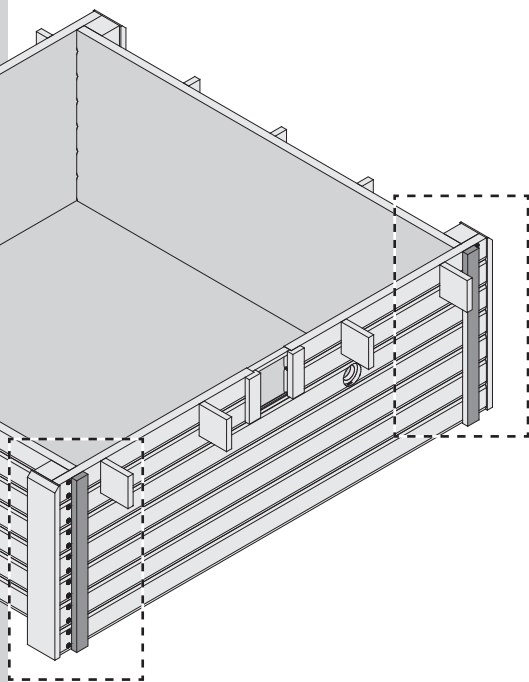
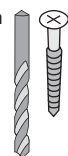

03

Ø3 mm 4x50

8x

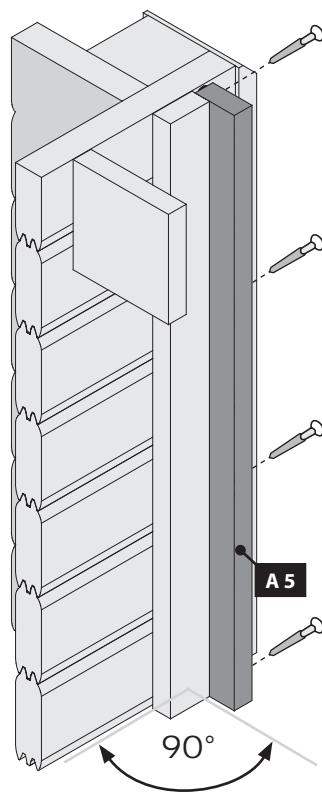
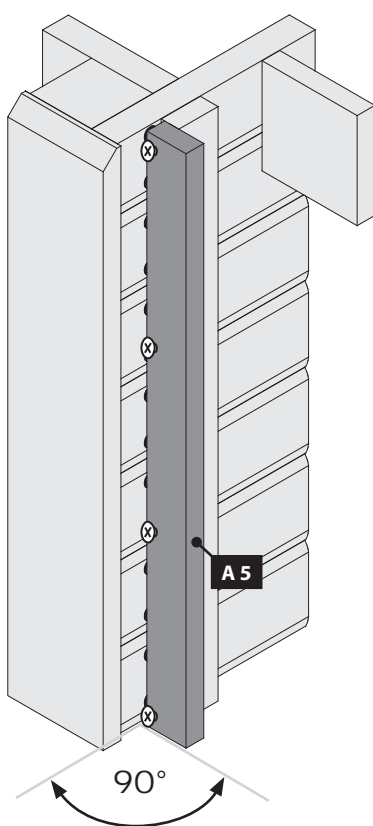
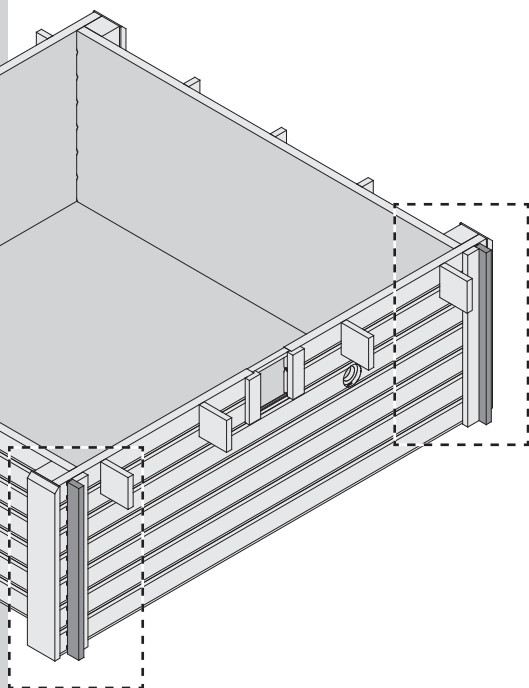
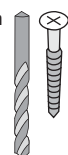

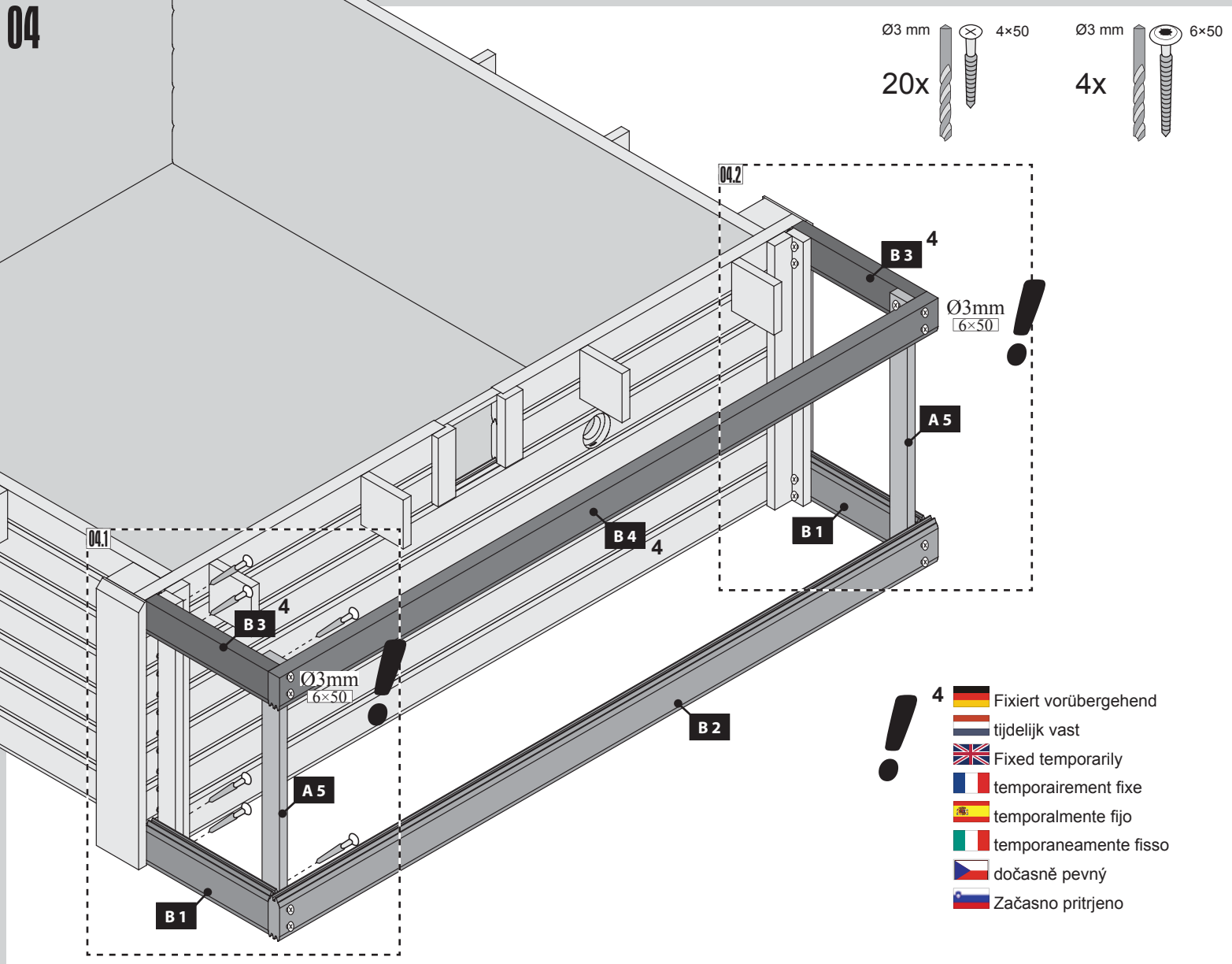
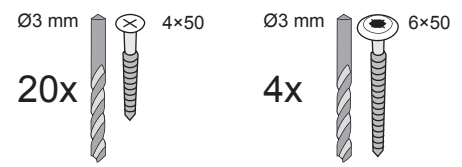

- 4 Fixiert vorübergehend
- tijdelijk vast
- Fixed temporarily
- temporairement fixe
- temporalmente fijo
- temporaneamente fisso
- dočasně pevný
- Začasno pritrjeno

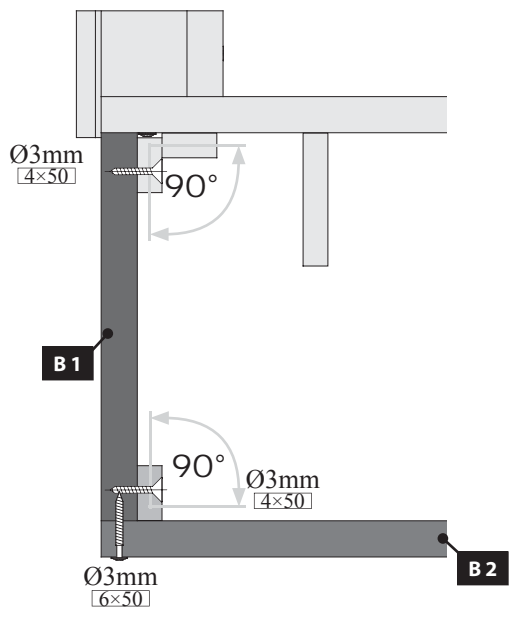

04.1



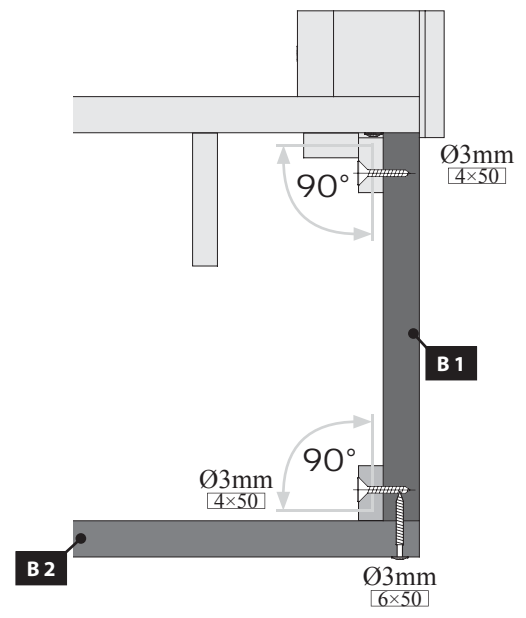



04.2



- Draufsicht
- Top view
- vue de dessus
- bovenaanzicht
- vista desde arriba
- vista desde arriba
- vista dall'alto
- púdorys

 Achten Sie auf die gleiche Höhe
 Look for the same height
 Faites attention à la même hauteur

 Besteed aandacht aan de dezelfde hoogte
 Prestar atención a la misma altura
 Prestare attenzione alla stessa altezza

 Dávejte pozor na stejnou výšku
 Pazite na enako výšino

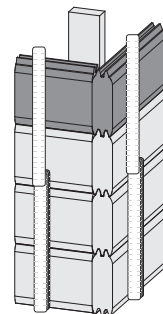
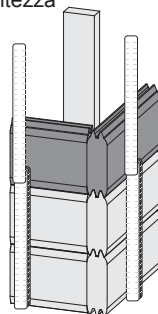
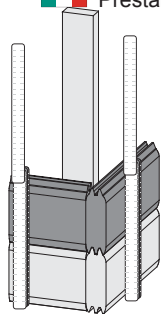
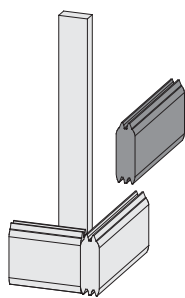

04

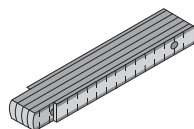

Ø3 mm  4x50
 32x

Ø3 mm  6x50
 16x

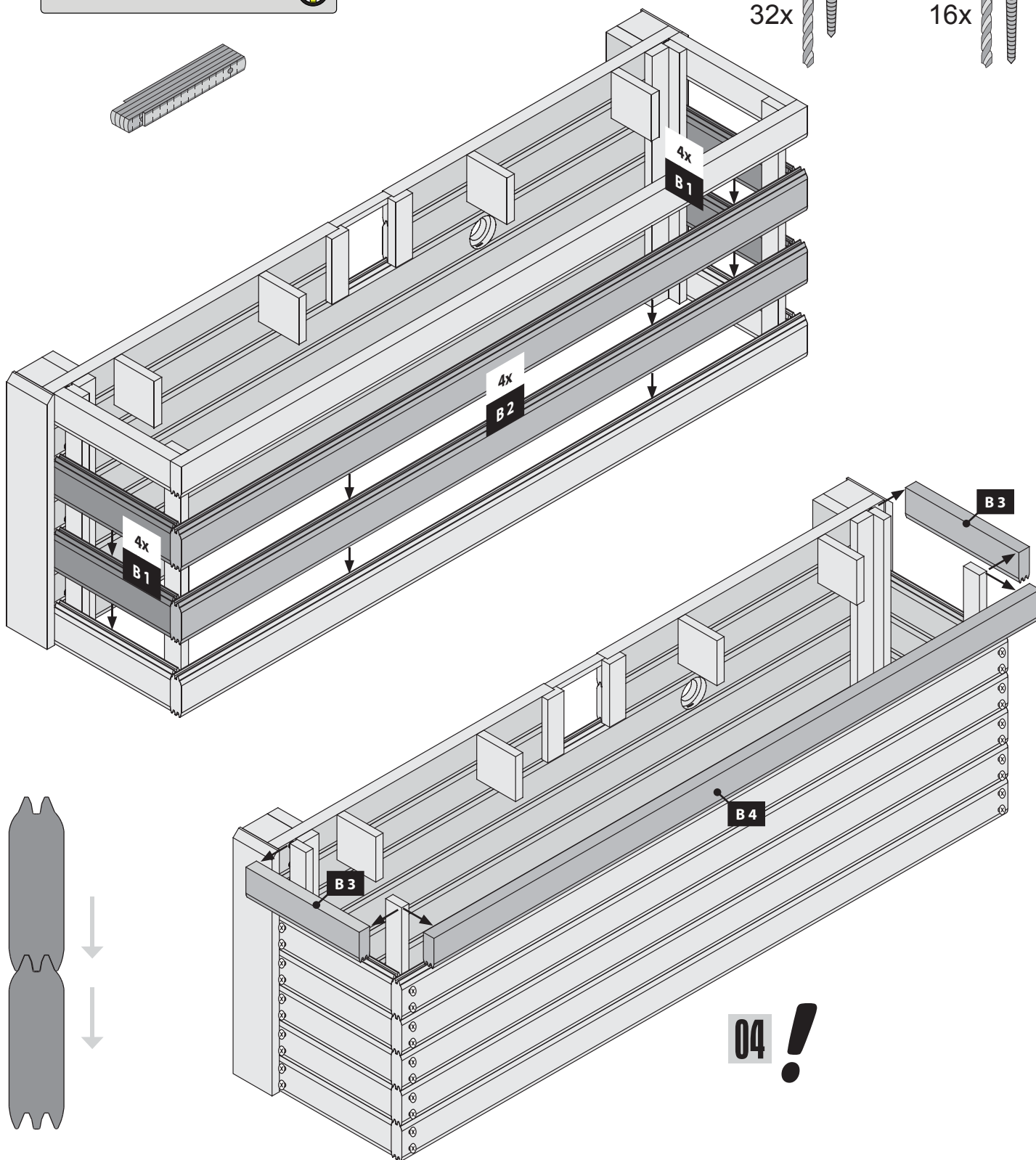

04 !

Ø3 mm 4×50 16x
Ø3 mm 6×50 8x

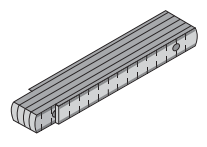
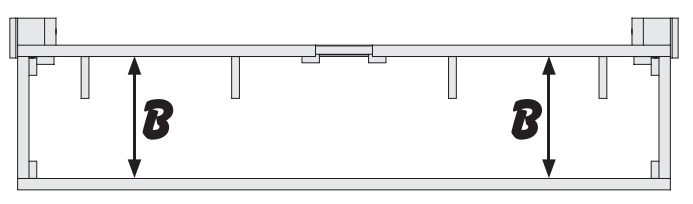
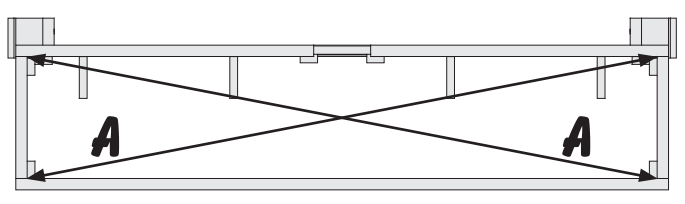
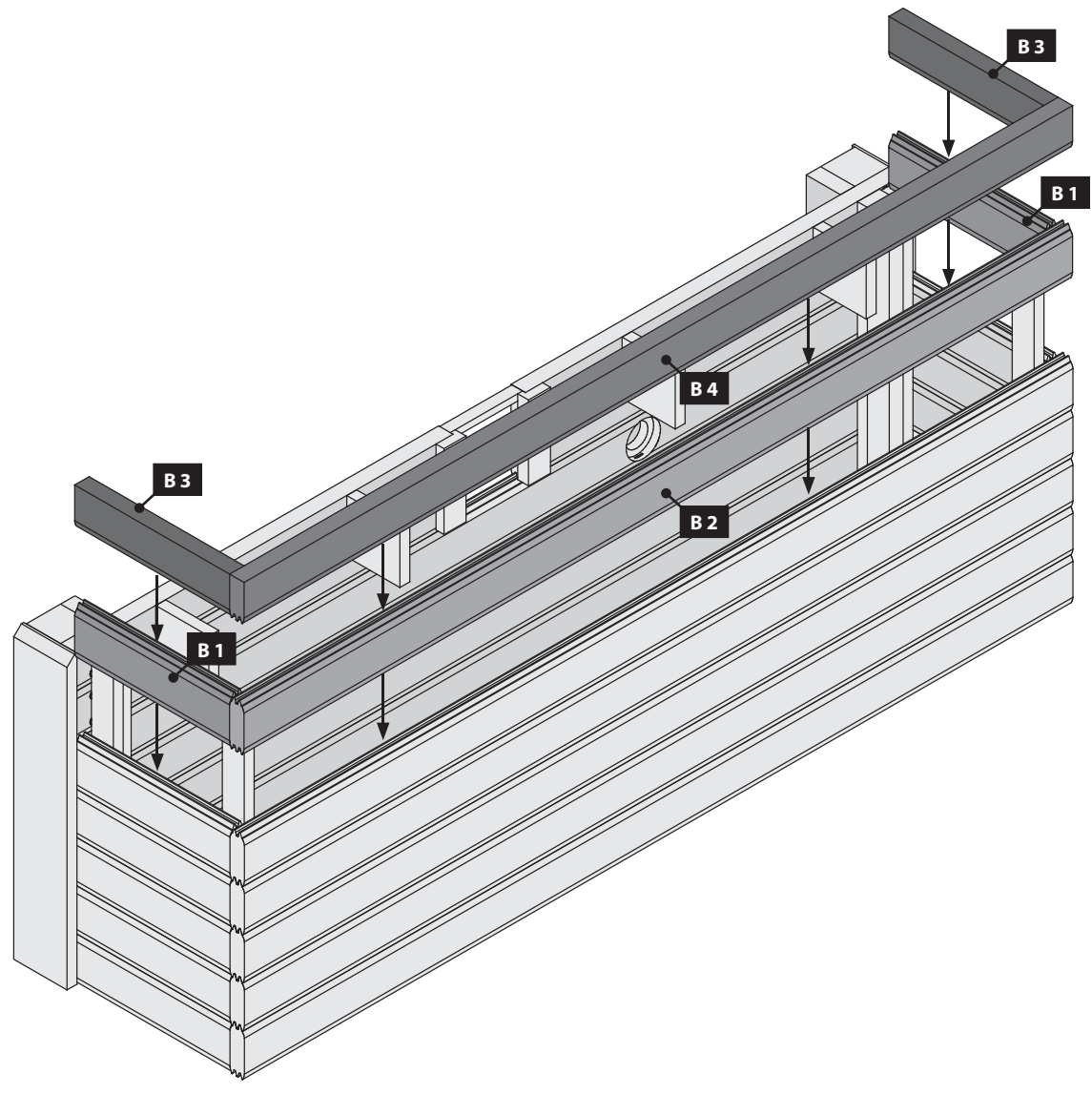

- Ø3 mm 4x35 12x
- Ø5 mm 6x60 8x

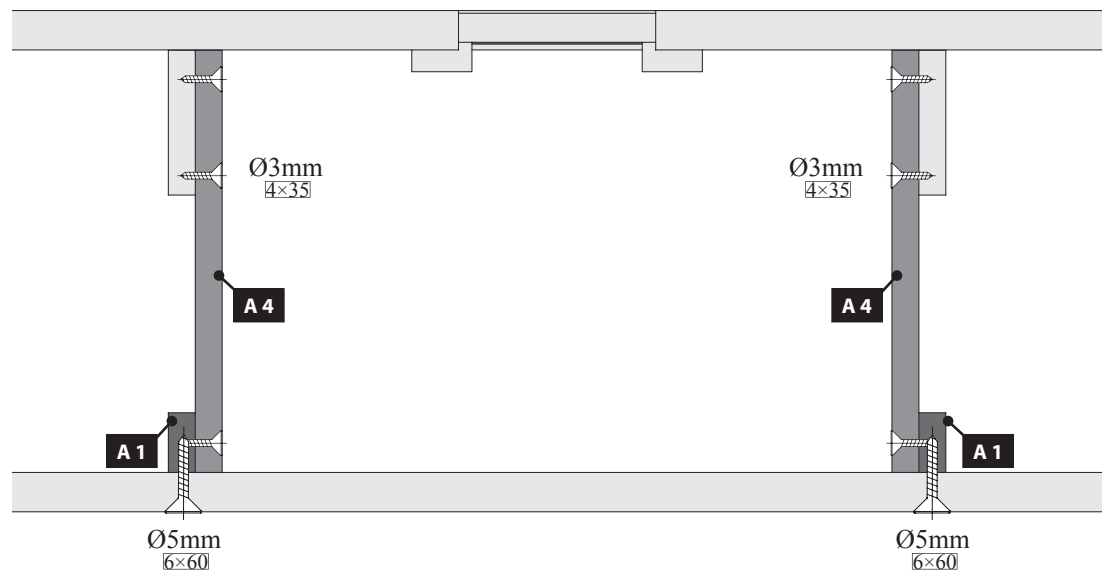
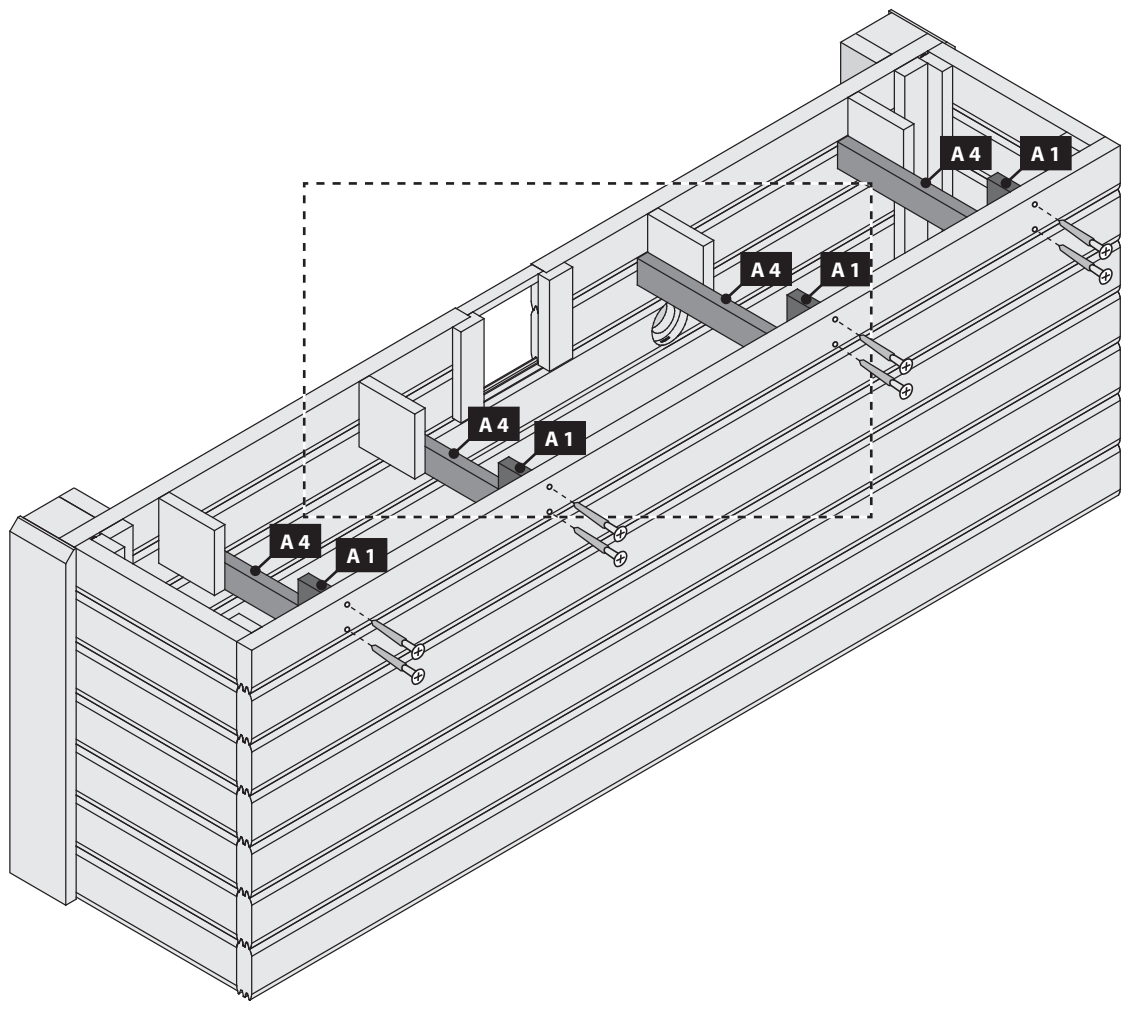

Ø3 mm 4x35

12x

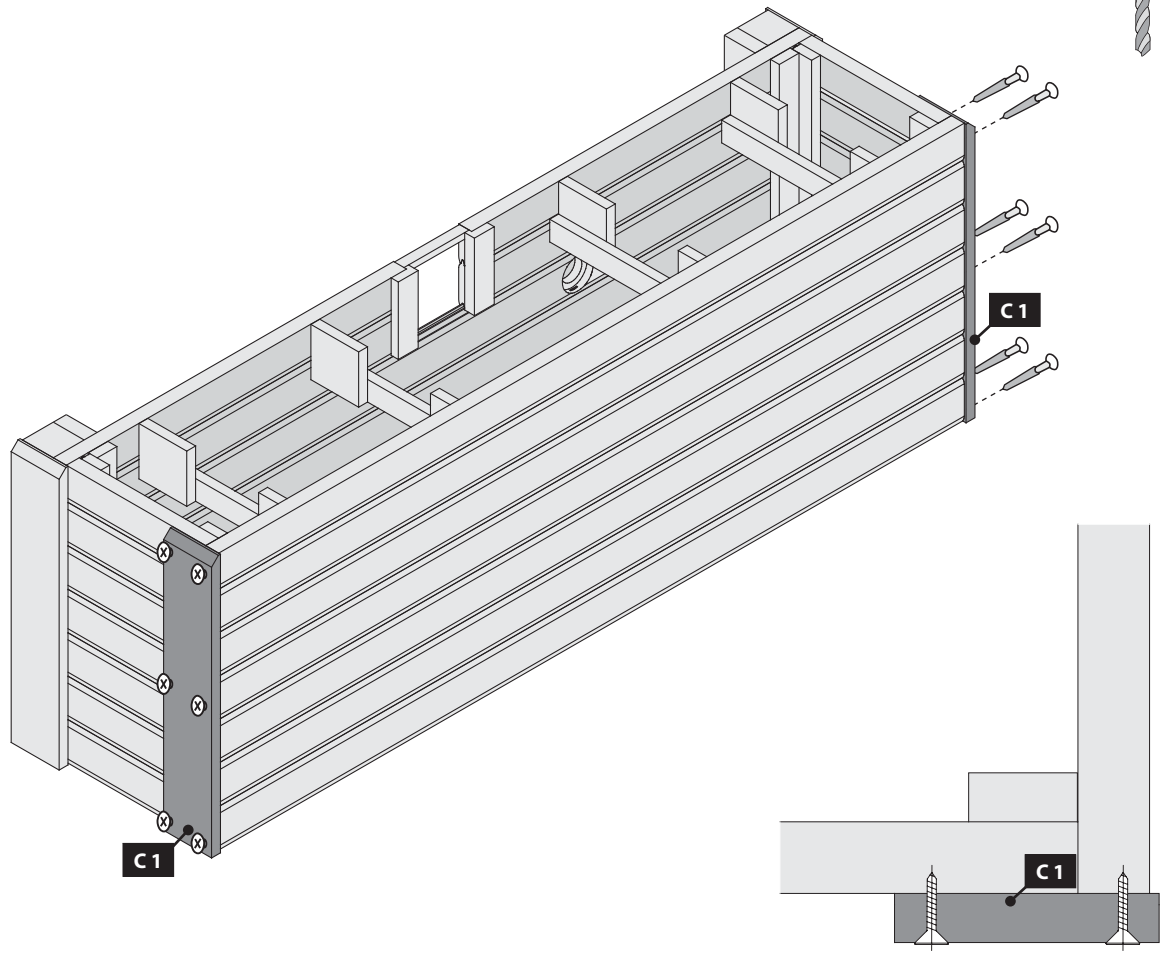

Ø3 mm 4x35

13x

-  Bündig!
-  Flush!
-  Affleurement!
-  Gelijk!
-  I flugt!
-  Aras!
-  Combacia!
-  Stejný!

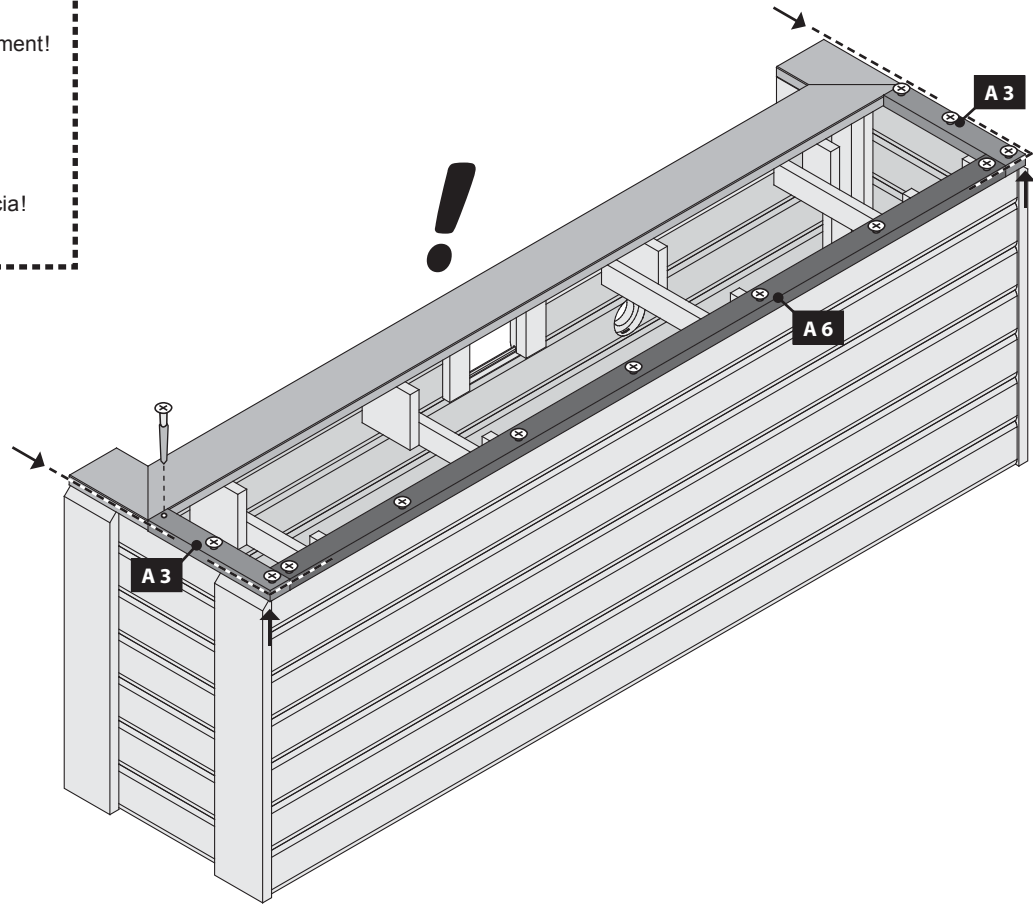

Ø3 mm 4x35

16x

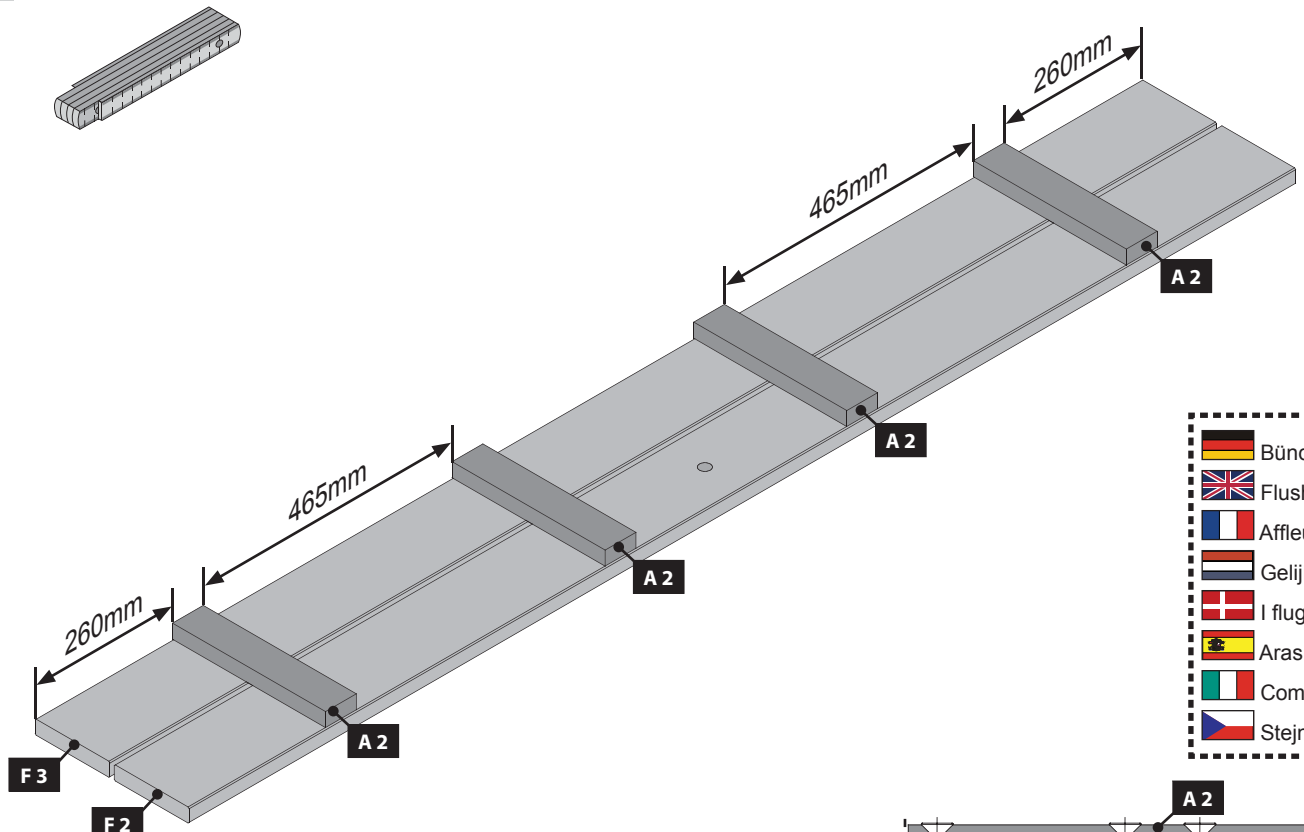

-  Bündig!
-  Flush!
-  Affleurement!
-  Gelijk!
-  I flugt!
-  Aras!
-  Combacia!
-  Stejný!

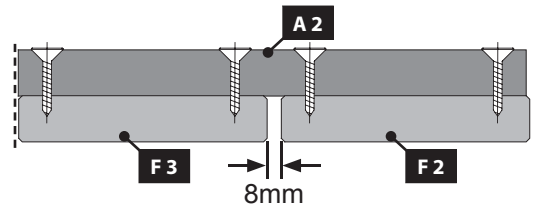

Ø3 mm 4x25

14x

