

DE	Pumpendatenblatt
EN	Data sheet
FR	Fiche technique pompe
NL	Pompgegevens
IT	Documentazione pompa
ES	Ficha técnica de la bomba

BADU[®] Eco Flex

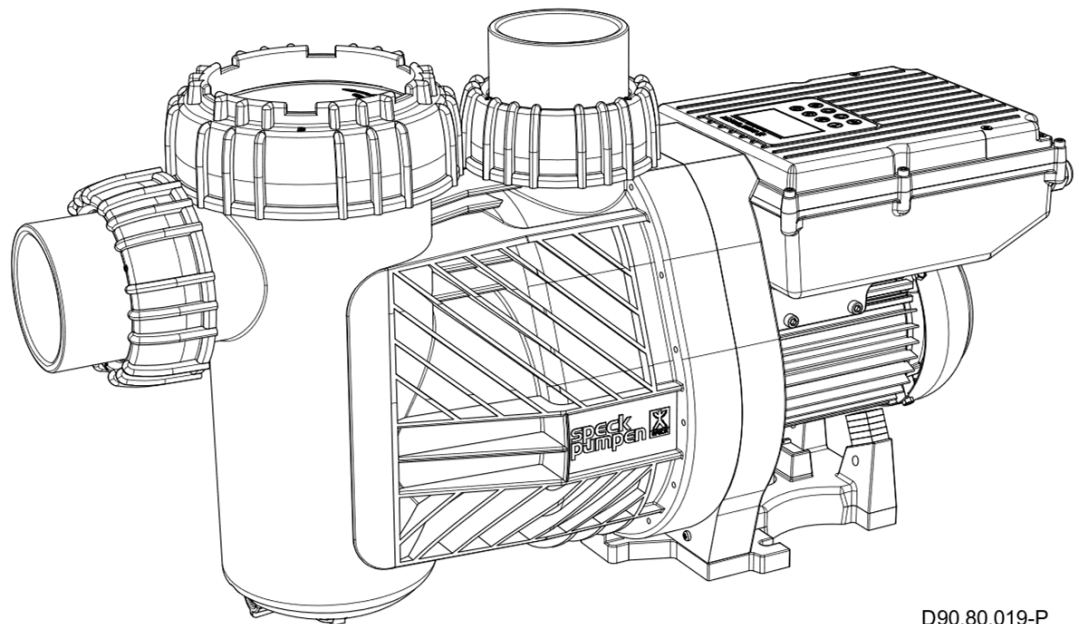

D90.80.019-P





BADU® ist eine Marke der
SPECK Pumpen Verkaufsgesellschaft GmbH

Hauptstraße 3
91233 Neunkirchen am Sand, Germany

Telefon 09123 949-0
Telefax 09123 949-260
info@speck-pumps.com
www.speck-pumps.com

Alle Rechte vorbehalten.

Inhalte dürfen ohne schriftliche Zustimmung von
SPECK Pumpen Verkaufsgesellschaft GmbH weder
verbreitet, vervielfältigt, bearbeitet noch an Dritte
weitergegeben werden.

Dieses Dokument sowie alle Dokumente im Anhang
unterliegen keinem Änderungsdienst!

Technische Änderungen vorbehalten!

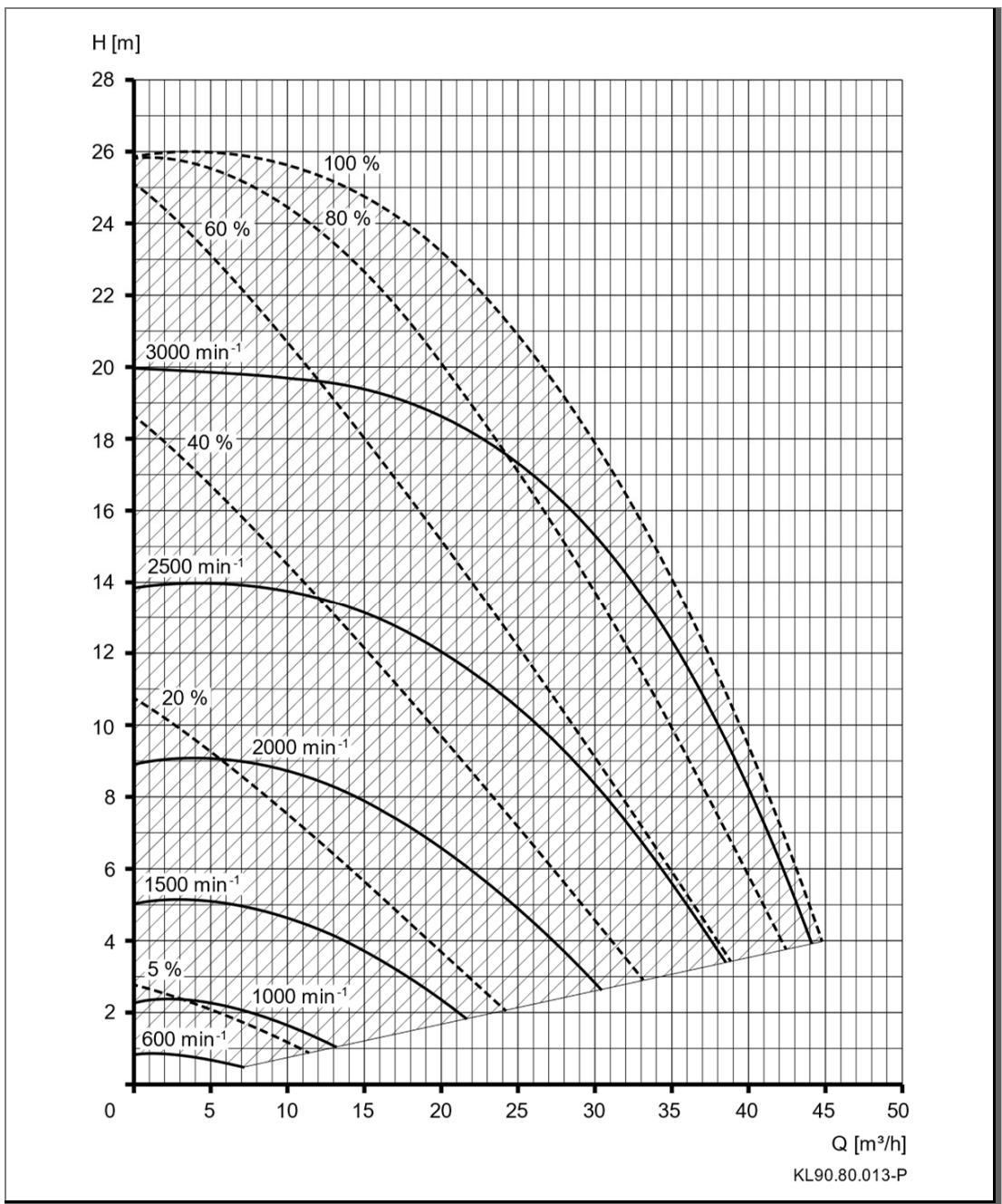
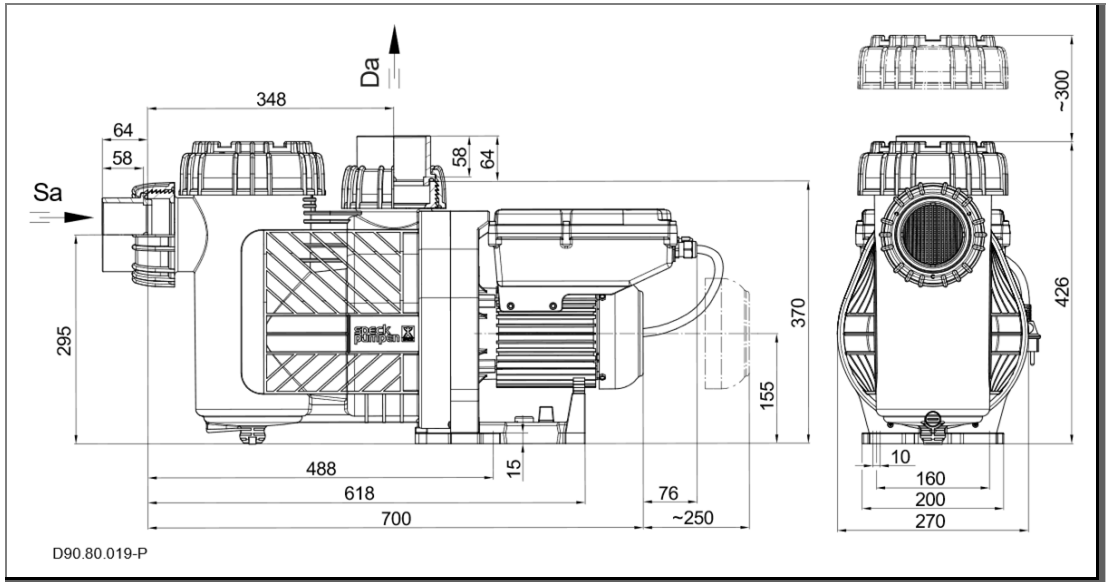

TD 50 Hz	Sa [Rp]	Da [Rp]	d-Saug [mm]	d-Druck [mm]	max. L [mm]
BADU Eco Flex	90	90	90	90	776

1~ 230 V

TD 50 Hz	n [min ⁻¹]	P ₁ [kW]	P ₂ [kW]	I [A]	L _{pa} (1m) [dB(A)]	L _{wa} [dB(A)]	m [kg]	WSK/PTC
BADU Eco Flex	600	0,08	0,05	0,45	39,2	47	24,5	○/●
BADU Eco Flex	3000	2,60	2,20	11,5	72,8	81	24,5	○/●
BADU Eco Flex	3400*	2,70	2,20	12,0	72,8	81	24,5	○/●

TD 50 Hz	n [min ⁻¹]	H _{max.} [m]	SP	Hs [m]	Hz [m]	IP	W-KI	T [°C]	P-GHI [bar max.]
BADU Eco Flex	600	0,80	○	3	3	55	F	40(60)	2,5
BADU Eco Flex	3000	20,0	●	3	3	55	F	40(60)	2,5
BADU Eco Flex	3400*	26,0	●	3	3	55	F	40(60)	2,5

* Bei Betriebsart „konstante Leistung“

* At operation mode „constant performance“

* Mode de fonctionnement „puissance constante“

* Bedrijfsmodus „constante capaciteit“

* Modo operativo „potenza costante“

* Modo operativo „potencia constante“

DE Pumpendatenblatt

Mitgeltende Dokumente

Zu diesem Pumpendatenblatt gehört die Originalbetriebsanleitung "Normal- und selbstansaugende Pumpen mit/ohne Kunststofflaternen-Ausführung (-AK)". Sie muss für das Bedien- und Wartungspersonal frei zugänglich sein.

BADU[®] Eco Flex

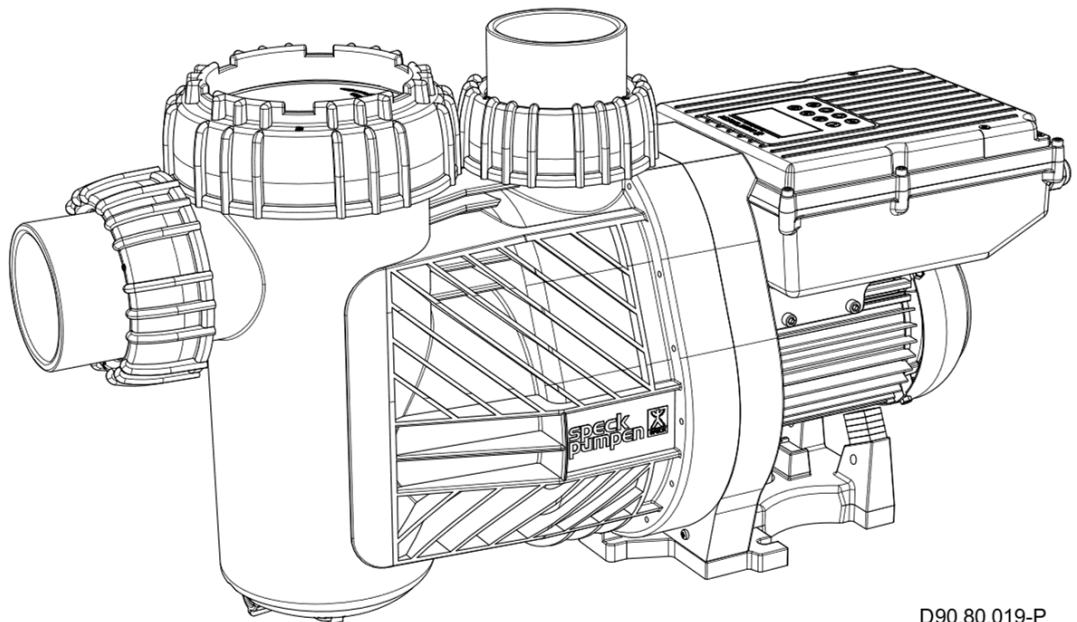

D90.80.019-P

Glossar	
TD	Technische Daten
Sa	Sauganschluss
Da	Druckanschluss
d-Saug	Empfohlener Durchmesser der Saugleitung bis 5 m
d-Druck	Empfohlener Durchmesser der Druckleitung bis 5 m
max. L	Maximale Länge der Pumpe
D	Dichte
P ₁	Aufgenommene Leistung
P ₂	Abgegebene Leistung
I	Nennstrom
L _{pa} (1 m)	Schalldruckpegel in 1 m Entfernung gemessen nach DIN 45635
L _{wa}	Schalleistung
m	Gewicht
WSK	Wicklungsschutzkontakt oder Motorschutzschalter
PTC	Kaltleiter
H _{max.}	Maximale Förderhöhe
SP	Selbstansaugend
H _s ; H _z	Geodätische Höhe zwischen Wasserspiegel und Pumpe
H _s	Maximale Saughöhe
H _z	Maximale Höhe bei Zulaufbetrieb
IP	Schutzart des Motors
W-KI	Wärmeklasse
n	Drehzahl
P-GHI	2,5 bar max. Gehäuseinnendruck/max. Systemdruck
T	Wassertemperatur
●	Ja
○	Nein
T/°C	Erläuterung Wassertemperatur 40 °C (60 °C): 40 °C = gilt für maximale Wassertemperatur im Sinne des GS-Zeichens. (60 °C) = Pumpe ist ohne weiteres für eine maximale Wassertemperatur von 60 °C einsetzbar/ausgelegt.
1~/3~	Geeignet für Dauerbetrieb bei 1~ 220 - 240 V ± 5% 3~ Y/Δ 380 - 420 V/220 - 240 V ± 5% 3~ Y/Δ 660 - 725 V/380 - 420 V ± 5% Für Normspannung geeignet nach DIN IEC 60038; DIN EN 60034

Die Pumpe besitzt einen Permanentmagnet-Motor und ist elektronisch vor Überlastung gesichert.

Anschluss externer Schaltkontakte

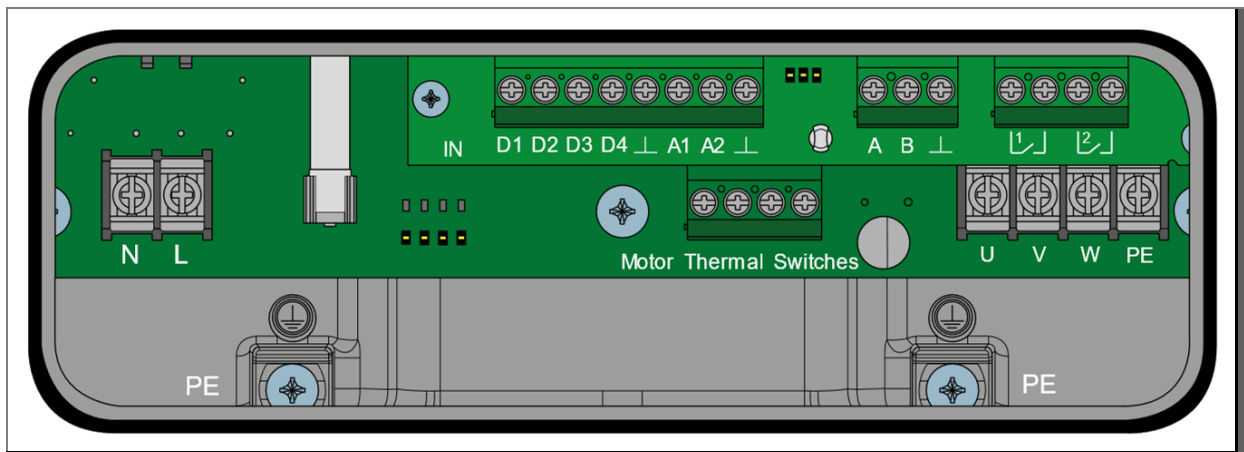

Typ	Klemme	Beschreibung
Netzanschluss	L	1~ 230V 50/60 Hz
	N	
	PE	Schutzleiter
Digitaleingänge (potentialfrei)	D1	Braun = n1
	D2	Grün = n2
	D3	Weiß = n3
	D4	Rot = Stopp
	⊥	Schwarz = GND
Analogeingänge	A1	0-10 V
	A2	4-20 mA
	⊥	GND
RS485	A	RS485+
	B	RS485-
	⊥	GND
Relais	1	Motorzustandwiedergabe max. 5A-250 V AC/5 A-30 V DC
	2	
Motor Thermal Switches	PTC1	Grau – Grau
	PTC2	Weiß – Weiß
Motoranschluss	U	Braun
	V	Blau
	W	Schwarz
	PE	Grün/Gelb



WG27.50.094-1-P

Motorzustandswiedergabe über Relais 1 und 2

Das Relais 1 schließt, sobald der Motor mit Netzspannung versorgt wird und kein Fehler vorliegt. Bei einem Fehler öffnet das Relais 1 wieder. Das Relais 2 schließt, sobald der Motor läuft.

Diese Wiedergabe des Motorzustandes bietet keine 100-%ige Sicherheit, dies wird nur durch einen Strömungs- oder Drucksensor gewährleistet.

Schaltverhalten Analogsignal

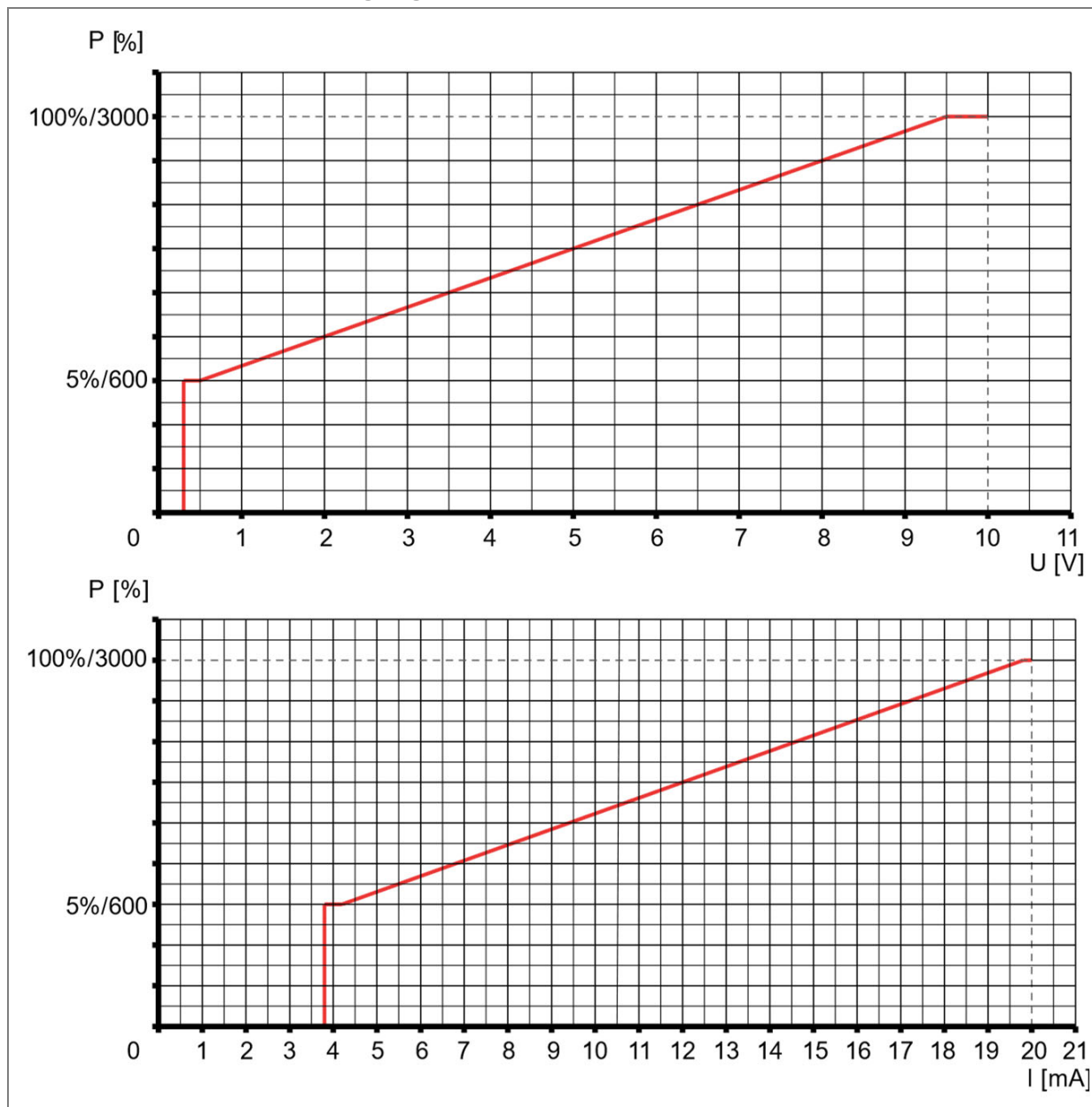

HINWEIS

Einschalten der Motordrehzahl mittels Handtaster oder externer Schaltkontakte. Dadurch Aktivierung der Schaltkontakte und der zugeordneten Drehzahl.

Startet die Pumpe aus dem Stillstand heraus, läuft sie im Ansaugmodus an und anschließend mit der ausgewählten Festdrehzahl, mit Ausnahme der analogen Ansteuerung 0-10 V, 4-20 mA und RS485.

Im laufenden Betrieb werden die Festdrehzahlen direkt angefahren, ohne Ansaugzeit.

Wird die externe Ansteuerung nicht benötigt, müssen die Kabelenden isoliert werden.

HINWEIS

Für das problemlose Zusammenspiel mit Peripheriegeräten, wie z.B. Elektrowärmetauscher oder Dosieranlagen, wird der Einbau eines Strömungswächters mit entsprechender Auswerteeinheit empfohlen. Damit kann auch eine Störmeldung ausgegeben werden.

HINWEIS

Um Fehlfunktionen im Motor zu vermeiden, müssen folgende Punkte unbedingt beachtet werden:

- Die Steuerleitung muss fachlich korrekt verlegt werden. Eine Montage parallel zur eigenen Netzleitung oder anderen Verbrauchern muss vermieden werden.
 - Sollten die Steuerleitungen verlängert werden, können gefährliche Spannungen am Digitaleingang entstehen. Diese müssen zum Beispiel durch Abschirmung verhindert werden.
 - Die Netzkabel verschiedener Betriebsmittel nicht am gleichen Versorgungsstrang betreiben.
-

Auswahl der Betriebsart

Bei diesem Motor kann zwischen zwei Betriebsarten (Modi) unterschieden werden. Der Motor kann entweder über die Drehzahl oder über die Leistung geregelt werden.

Bei dem Modus „konstante Drehzahl“ wird die gewünschte Drehzahl am Motor eingestellt und diese Drehzahl über die Kennlinie konstant gehalten.

Bei dem Modus „konstante Leistung“ wird die gewünschte Leistung in % am Motor eingestellt und über die ganze Kennlinie hinweg konstant gehalten. Der Motor regelt hier entsprechend der eingestellten Leistung die Drehzahl selbstständig.

Modus	Konstante Drehzahl *	Konstante Leistung
Voreinstellung: Drehzahl/Leistung:	1 = 2000 min ⁻¹ 2 = 2500 min ⁻¹ 3 = 3000 min ⁻¹	1 = 60 % 2 = 80 % 3 = 100 %
Ansaugdrehzahl/ Ansaugleistung: Ansaugzeit:	= 3000 min ⁻¹ = 5 Minuten	= 100 % = 5 Minuten
Einstellbare Drehzahl/ Leistung:	600 – 3000 min ⁻¹ (in 10 min ⁻¹ Schritten)	5 – 100 % (in 1 % Schritten)
Einstellbare Ansaugzeit:	aus, 1 – 10 min. (in 1 min. Schritten)	aus, 1 – 10 min. (in 1 min. Schritten)
Sprache	Englisch	Englisch
Externe Ansteuerung:	keine	keine

* Die Funktion „konstante Drehzahl“ ist Werkseinstellung.

Menüstruktur Setup

Je nach Auswahl beziehungsweise Einstellung werden Menüpunkte nach folgendem Diagramm ein- oder ausgeblendet.

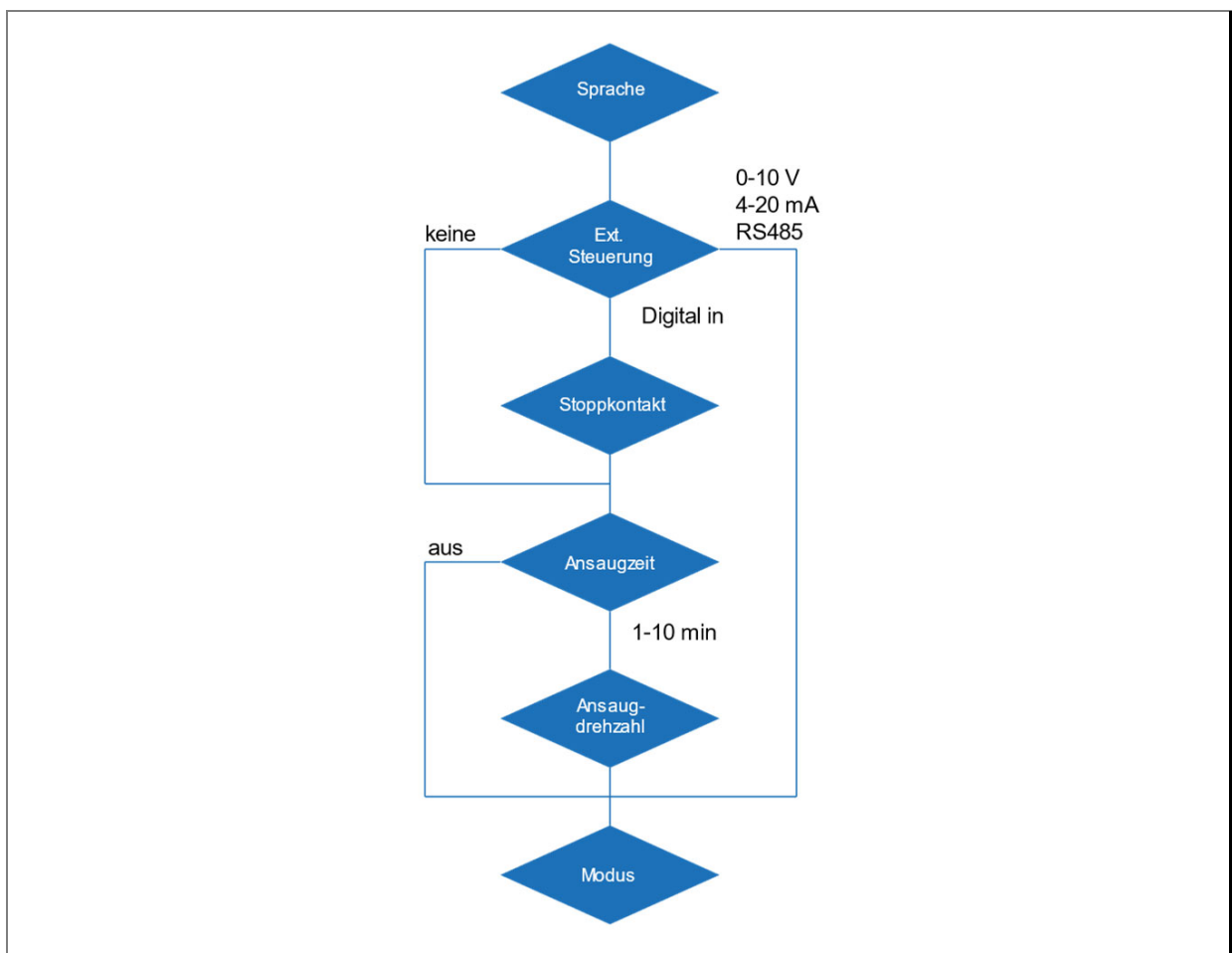



	<p>Bedienoberfläche:</p> <p>(1) LCD-Display: zeigt die aktuelle Drehzahl/ Leistungsstufe des Motors an.</p> <p>(2) 1 2 3 : Auswahl der voreingestellten Drehzahlen/Leistungsstufen</p> <p>(3) INFO : Zur Anzeige des aktuellen Verbrauchs und Auswahl der Menüpunkte im Setup</p> <p>(4) S : Zum Einstellen der Parameter</p> <p>(5) ▼ ▲ : zum Ändern der Drehzahl/ Leistungen/Parameter</p> <p>(6) 0 : zum Stoppen des Motors</p>
--	---

	<p>Bedienung:</p> <p>Taste 1 2 oder 3 drücken, um die voreingestellte Drehzahl/Leistung auszuwählen. Startet die Pumpe aus dem Stillstand heraus, läuft sie im Ansaugmodus an (sofern dieser aktiviert) und anschließend mit der ausgewählten Festdrehzahl/Leistungsstufe.</p> <p>Im laufenden Betrieb werden die Drehzahlen/Leistungsstufen direkt angefahren, ohne Ansaugzeit. Durch Drücken der Taste 0 wird der Motor gestoppt. Ist in den Parametern eine analoge Ansteuerung oder RS485 eingestellt, kann mit der Taste 1 der Motor wieder gestartet werden.</p>
--	---

	<p>Einstellen der Drehzahlen/Leistungen:</p> <p>Die Taste der Festdrehzahl/Leistungsstufe die verändert werden soll drücken (1 2 3) und danach mit den Tasten ▼ ▲ die Drehzahl/Leistung ändern. Die eingestellte Drehzahl/Leistung wird direkt gespeichert und bei erneuter Auswahl der Festdrehzahl/ Leistungsstufe angefahren.</p>
--	---

	<p>Hinweis: Während der Ansaugphase kann die Drehzahl/Leistung nicht verändert werden.</p>
--	---



	<p>Einstellen der Parameter: Durch Drücken der Taste S für 3 Sekunden wird in das Setup-Menü gewechselt. Dort kann mit der INFO-Taste durch das Menü geblättert werden und mit den Tasten ▼ ▲ Parameter und Einstellungen geändert werden. Wird die Taste S innerhalb des Menüs gedrückt, dann werden alle geänderten Werte gespeichert und das Setup-Menü verlassen. Durch Drücken der Taste 0 wird das Setup-Menü ohne Speicherung der geänderten Werte verlassen.</p>
---	--



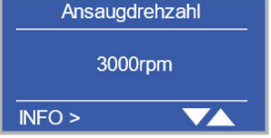

	<p>Sprache: Bei dem Menüpunkt „Sprache“ kann die Sprache eingestellt werden. Über die Tasten ▼ ▲ kann zwischen den Sprachen umgestellt werden. Folgende Sprachen sind auswählbar:</p> <ul style="list-style-type: none"> • Deutsch • Englisch • Französisch • Italienisch • Niederländisch • Spanisch
---	--

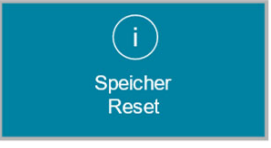
	<p>Digitale und analoge Eingänge: Bei dem Menüpunkt „Externe Ansteuerung“ kann die Art der externen Ansteuerung festgelegt werden. keine = deaktiviert Digital in = Digitaleingänge (potentialfrei) aktiviert 0-10 V = Analogeingang 0-10 V 4-20 mA = Analogeingang 4-20 mA RS485 = Protokoll auf Anfrage</p>
---	---

	<p>Schaltverhalten Stoppkontakt: Unter dem Punkt Stoppkontakt kann das Schaltverhalten des Digitaleingangs Stopp geändert werden. Schließen bedeutet, der Antrieb wird bei geschlossenem Stopp-Kontakt gestoppt. Öffnen bedeutet, der Antrieb wird bei offenem Stopp-Kontakt gestoppt. Ohne Signal bedeutet, der externe Kontakt zum Stoppen wird nicht benötigt. Öffnen des GND-Kontaktes stoppt den Antrieb.</p>
---	--

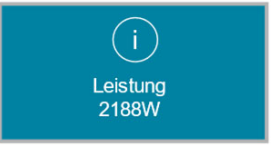
	<p>Ansaugparameter: Unter den Menüpunkten „Ansaugzeit“ und „Ansaugdrehzahl/-leistung“ kann eine Zeit und Drehzahl/Leistung definiert werden, mit der die Pumpe nach einem Stillstand das Wasser ansaugt und die Rohrleitung entlüftet.</p>
	

	<p>Zurücksetzen / Reset: Wird die -Taste für mindestens 10 Sekunden gedrückt, dann wird der Antrieb auf die Werkseinstellungen zurückgesetzt. Der Motor stoppt und im Display steht „Reset“.</p>
---	--

	<p>Durch Drücken der -Taste wird im Display der aktuelle Leistungsbedarf, die Software-Version und der letzte Fehler angezeigt.</p>
	<p>Das Display der Steuerung schaltet sich nach fünf Minuten ohne Aktion ab.</p>
	

Die Pumpe läuft nach einem Spannungsverlust automatisch wieder mit der zuletzt eingestellten Drehzahl an oder bleibt stehen, wenn sie zuvor gestoppt wurde.

Das Ein- und Ausschalten der Pumpe sollte über das dafür vorgesehene Steuerkabel (potentialfreie Kontakte), das Analogsignal oder RS485 realisiert werden. Dies kann z. B. über eine BADU-Logic-Steuerung, BADU OmniTronic oder über ein kleines Koppelrelais geschehen. Dadurch wird die Elektronik weniger belastet.

Übersicht möglicher Warnungen und Fehlermeldungen

Warnungen



Warnungen weisen auf grenzwertige Systemzustände hin. Sie werden alle zehn Sekunden angezeigt, solange kein Fehler vorliegt. Bei hohen Temperaturen wird die aktuell gemessene Temperatur des betroffenen Bauteils (PCB – Platine, PFC oder IPM – Powermodul) angezeigt. Nach

einiger Zeit wird das Gerät in den Derating-Modus versetzt und die Leistung gedrosselt. Derating wird ebenfalls als Warnung angezeigt und überschreibt zuvor angezeigte Übertemperatur-Warnungen.

Warnung	Grenzwert
PCB Temperatur hoch	>86 °C
PFC Temperatur hoch	>86 °C
IPM Temperatur hoch	>86 °C
Eingangsspannung hoch	>255 V
Eingangsspannung niedrig	<206 V
Derating starts	Siehe Inverter Parameter

Fehlertyp



Jeder Fehler besitzt einen Fehler-Reaktionstypen, eine Anzahl an Wiederholungen der Reaktion bei weiter vorhandenem Fehler und eine Wartezeit zwischen den Wiederholungen des Fehlers (Timeout).

Reaktionstyp

Auto Try Again (ATA)	Für allgemeine Fehler: Das System übernimmt automatisch alle x Sekunden einen Fehler-Reset und versucht den letzten Systemzustand wiederherzustellen.
Wait on Action (WTA)	Für kritische Fehler: Nach einem Fehler-Reset durch den Anwender unternimmt das System das Wiederherstellen des letzten Systemzustandes.
Memory Reset (MR)	Für Fehler bei der Parametrierung und Initialisierung: Der Speicher wird auf Werkseinstellungen zurückgesetzt und ein System-Neustart des Applikationsboardes wird durchgeführt.
Bootloader Watchdog (BW)	Für updaten nicht kompatibler Software: Das Ausführen der Software wird unterbunden, ein Systemupdate ist erforderlich.

Durch langes Drücken (>3s) der  -Taste, kann ein Fehler quittiert und zurückgesetzt werden.

Fehler

Nr.	Fehlername	Reaktions- typ	Anzahl Wdh.	Time- out
1	Unterspannung	ATA	Unendlich	5s
2	Überspannung	WTA	Unendlich	5s
3	Falsche Spannung beim Start	ATA	1	10s
4	Übertemperatur Leistungsmodul	ATA	Unendlich	60s
5	Übertemperatur Motor	ATA	Unendlich	60s
6	Übertemperatur PCB	ATA	Unendlich	60s
8	Übertemperatur PFC	ATA	Unendlich	60s
98	Communication	ATA	Unendlich	8s
100	Drive Initialisation	ATA	Unendlich	15s
101	Keine externe Veröffentlichung	ATA	Unendlich	30s
102	Fehler bei Motorstart	WTA	Unendlich	30s
103	Überstromphase	WTA	1	5s
104	PFC Unterspannung	WTA	Unendlich	5s
105	Fehler Power Modul	WTA	Unendlich	5s
106	Power module passed on	WTA	Unendlich	5s
107	DCLink Überspannung	WTA	Unendlich	5s
200	HXIO Initialisierung	MR	Unendlich	30
201	HXIO Parametrisierung	MR	Unendlich	30s
202	HXIO RT Application	ATA	Unendlich	5s
210	HXIO Falsche HW-ID	BW	Unendlich	0s
211	HXIO Falsche HW Verison	BW	Unendlich	10s
222	HXIO COM PM	ATA	Unendlich	20s
223	HXIO COM PM Timeout	ATA	Unendlich	20s
224	HXIO COM UI Timeout	ATA	Unendlich	10s
225	HXIO COM SIO Timeout	ATA	Unendlich	10s
230	HXIO EEPROM Fehler	ATA	Unendlich	5s
231	HXIO EEPROM Fehler change block	ATA	1	5s

Tritt ein Defekt auf, so ist die Anlage von der Spannungsversorgung zu trennen. Siehe Kapitel 2.2 der Originalbetriebsanleitung "Normal- und selbstansaugende Pumpen mit/ohne Kunststofflaternen-Ausführung (-AK)".

Die folgenden Aufzählungen beziehen sich auf die mitgeltenden Dokumente!

Deckel/Saugsieb demontieren bzw. montieren

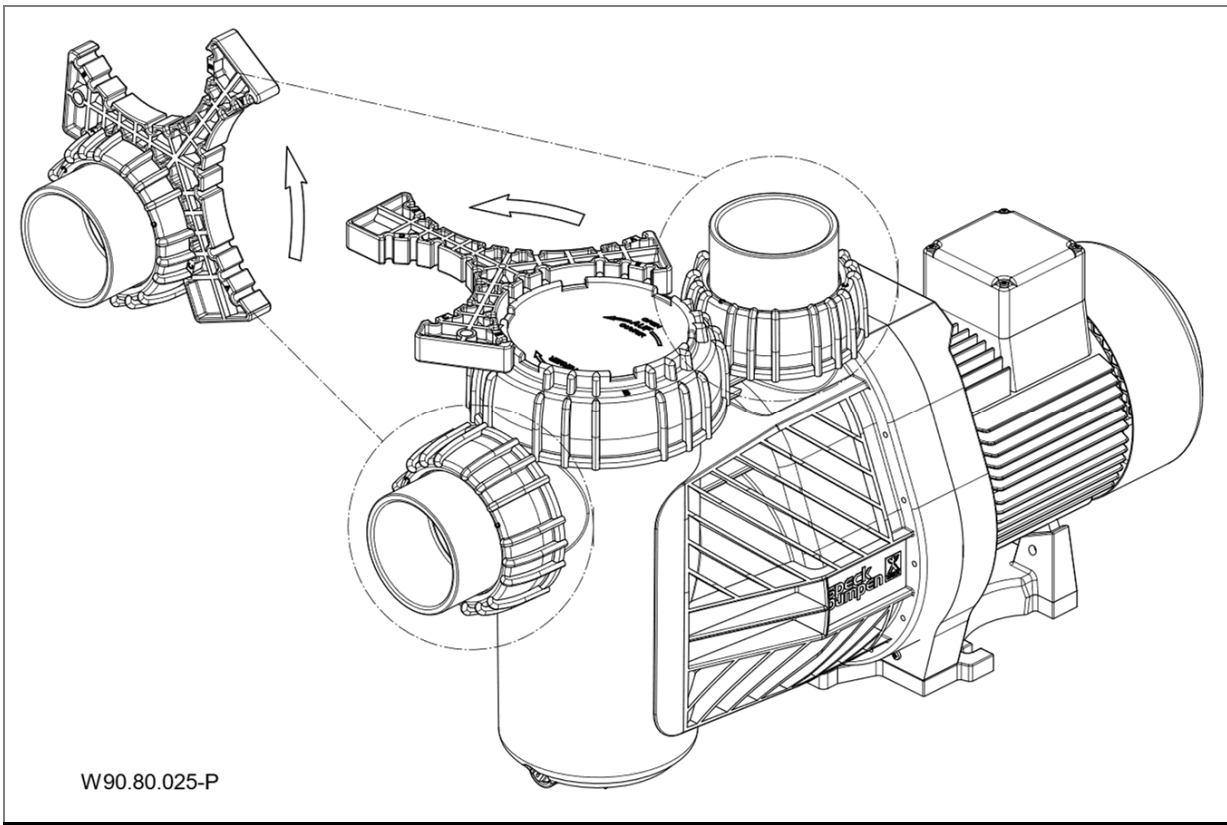

EN Data sheet**Related Documentation**

The additional information compiled in this data sheet must be kept together with the original operation manual for "Non-self-priming and self-priming pumps with/without plastic lanterns" and must be accessible to the relevant personnel at all times.

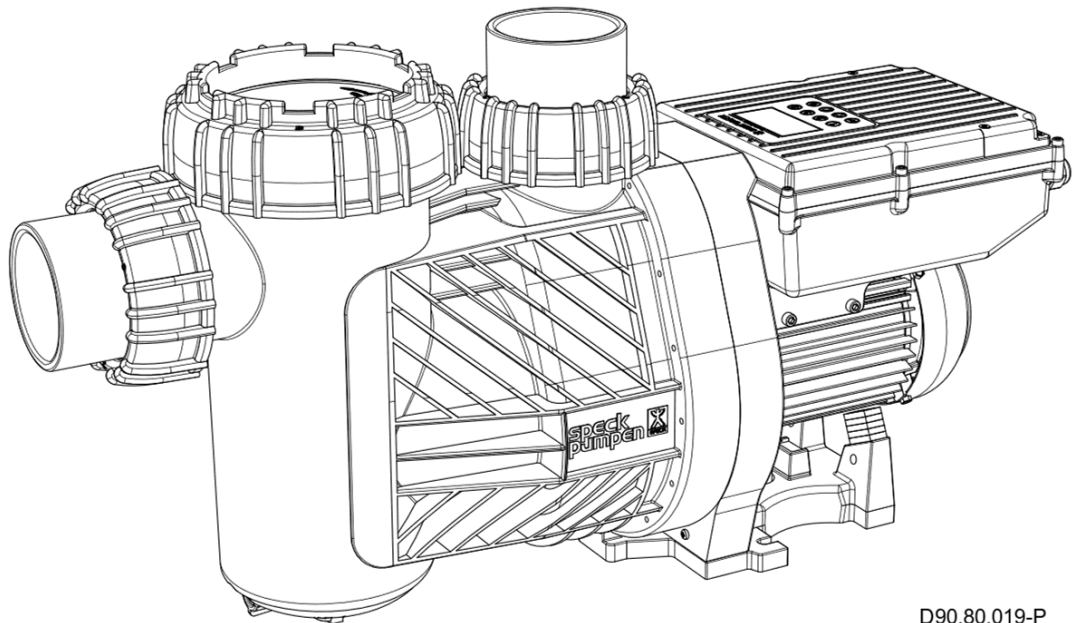
BADU[®] Eco Flex

D90.80.019-P

Glossary	
TD	Technical data
Sa	Inlet connection
Da	Outlet connection
d-Saug	Recommended diameter for the suction line from 5 m
d-Druck	Recommended diameter for the pressure line from 5 m
max. L	Maximum length of the pump
D	Density
P ₁	Power input
P ₂	Power output
I	Rated current
Lpa (1 m)	Sound pressure level at 1 m measured in accordance with DIN 45635
Lwa	Acoustic capacity
m	Weight
WSK	Built-in or external overload switch
PTC	PTC resistor
H _{max.}	Total dynamic head
SP	Self-priming
Hs; Hz	Geodetic head between water level and pump
Hs	Total suction head
Hz	Total dynamic head with flooded suction
IP	Type of motor enclosure
W-KI	Class of insulation
n	Motor speed
P-GHI	2.5 bar max. casing pressure/system pressure
T	Water temperature
●	Yes
○	No
T/°C	Clarification of the max. water temperature 40 °C (60 °C): 40 °C = the max. water temperature allowed according to the GS approval. (60 °C) = the pump is designed to withstand a max. water temperature of 60 °C.
1~/3~	Suitable for continuous operation at 1~ 220 - 240 V ± 5% 3~ Y/Δ 380 - 420 V/220 - 240 V ± 5% 3~ Y/Δ 660 - 725 V/380 - 420 V ± 5% For standard voltage in accordance with DIN IEC 60038; DIN EN 60034

The pump has a permanent magnetic motor and is electronically protected against overload.

Connecting external switch contacts

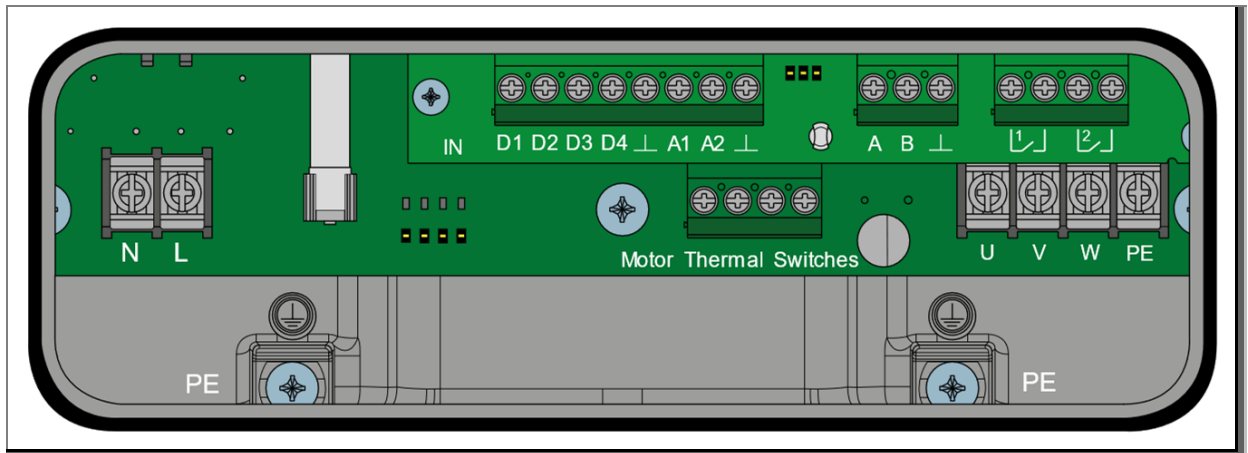

Type	Terminal	Description
Mains connection	L	1~ 230V 50/60 Hz
	N	
	PE	Protective conductor
Digital inputs (potential-free)	D1	brown = n1
	D2	green = n2
	D3	white = n3
	D4	red = stop
	⊥	black = GND
Analogue inputs	A1	0-10 V
	A2	4-20 mA
	⊥	GND
RS485	A	RS485+
	B	RS485-
	⊥	GND
Relay	1	Motor condition reproduction max. 5A-250 V AC/5 A-30 V DC
	2	
Motor thermal switches	PTC1	grey – grey
	PTC2	white – white
Motor connection	U	brown
	V	blue
	W	black
	PE	green/yellow

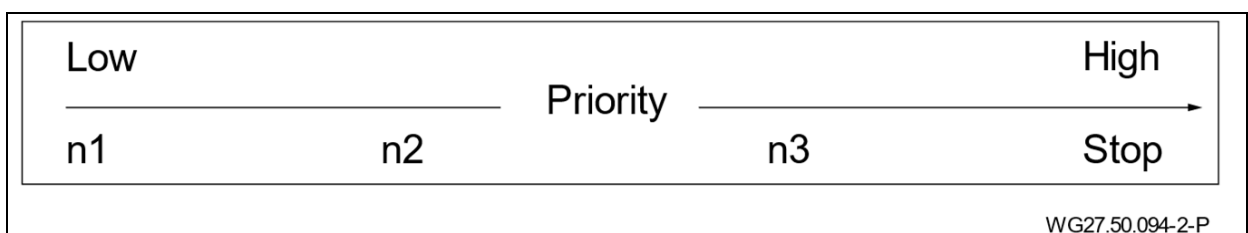

WG27.50.094-2-P

Motor condition reproduction via relays 1 and 2

Relay 1 closes as soon as mains voltage is supplied to the motor and there is no error. Relay 1 re-opens in case of an error. Relay 2 closes as soon as the motor starts running.

This reproduction of the motor condition offers no 100% reliability; this is only given by a flow or pressure sensor.

Analogue signal switching behaviour

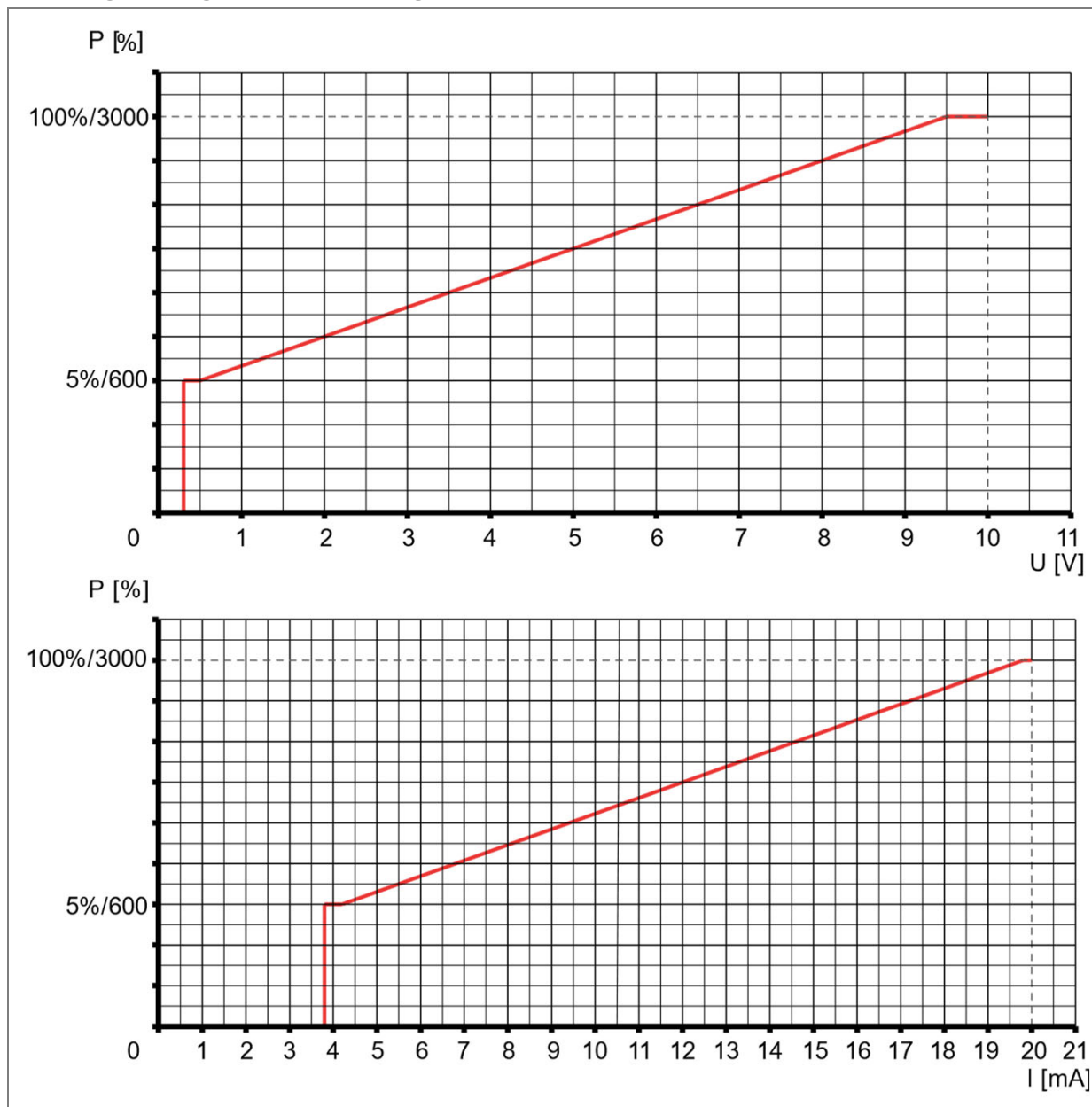

NOTICE

The motor speed is switched on using the manual button or external switch contacts. The switch contacts and the assigned speed are activated.

If the pump starts from standstill, it starts in suction mode and then with the selected fixed speed, with the exception of the analogue activation 0-10 V, 4-20 mA and RS485.

During operation the pump is started up to the fixed speed directly, without priming time.

If external control is not necessary, the cable ends need to be insulated.

NOTICE

For easy interaction with peripheral devices such as electric heat exchangers or dosing systems, installing a flow monitor with the appropriate evaluation unit is recommended. This can also output a fault message.

NOTICE

The following points must be observed in order to avoid motor malfunctions:

- The control line should be correctly installed by a specialist. Assembly parallel to power lines or their load should be avoided.
 - Should the control lines be extended, dangerous voltages can occur at the digital input. These should be avoided with isolation.
 - The power cables for various inputs should not be connected to the same supply line.
-

Selecting the operating mode

This motor has two different operating modes (modes). The motor can be controlled either by the speed or by the performance.

In the “constant speed” mode, the desired speed is set on the motor and this speed is kept constant over the characteristic.

In the “constant performance” mode, the desired performance in % is set on the motor and is kept constant over the whole characteristic. The motor controls the speed independently here according to the set performance.

Mode	Constant speed *	Constant performance
Default setting: Speed/performance:	1 = 2000 min ⁻¹ 2 = 2500 min ⁻¹ 3 = 3000 min ⁻¹	1 = 60 % 2 = 80 % 3 = 100 %
Priming speed/Priming performance: Priming time:	= 3000 min ⁻¹ = 5 minutes	= 100 % = 5 minutes
Speed/performance which can be set:	600 – 3000 min ⁻¹ (in 10 min ⁻¹ steps)	5 – 100 % (in 1 % steps)
Priming time which can be set:	off, 1 – 10 min. (in 1 min. steps)	off, 1 – 10 min. (in 1 min. steps)
Language:	english	english
External controlling:	none	none

* Constant speed is the default setting.

Set-up menu structure

The menu items are shown or hidden according to the following diagram depending on the selection or setting.

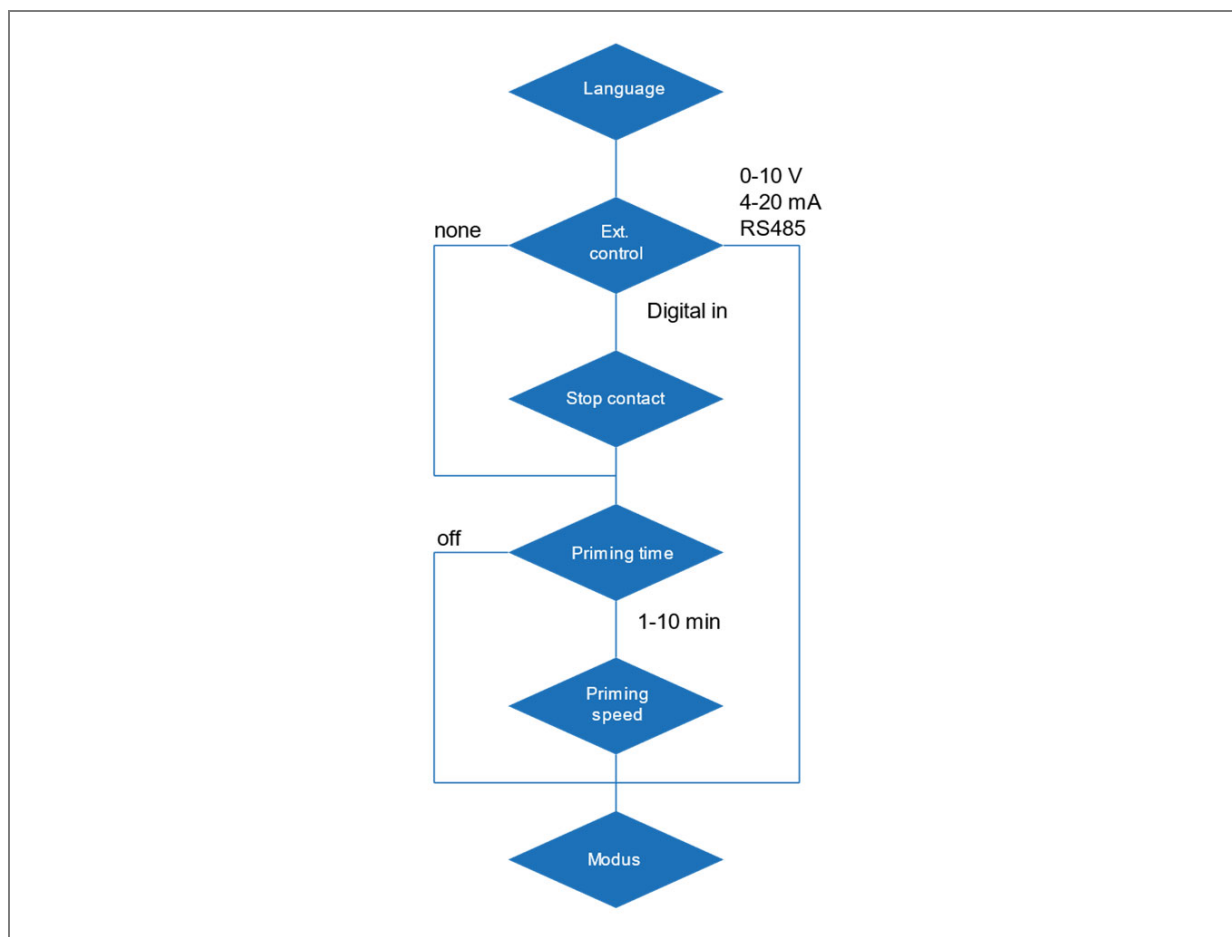

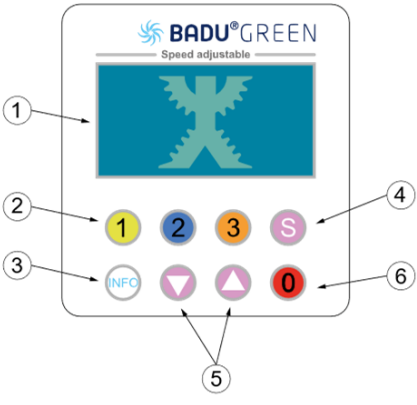

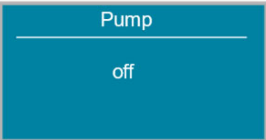
 <p>The diagram shows a control panel for BADU GREEN. At the top is a screen (1) displaying a green motor icon. Below the screen are six buttons: three colored buttons (1, 2, 3) for speed selection, an 'S' button (4) for settings, two arrow buttons (5) for adjustment, and a red '0' button (6) for stop. The screen also shows 'BADU GREEN Speed adjustable'.</p>	<p>User interface:</p> <p>(1) LCD display: displays the current speed/performance of the motor.</p> <p>(2) 1 2 3 : selection of the preset speeds/performance level.</p> <p>(3) INFO : to display the current consumption and select the menu points in the setup.</p> <p>(4) S : to set the parameters.</p> <p>(5) ▼ ▲ : to change the speed/performance/parameters</p> <p>(6) 0 : to stop the motor.</p>
---	---

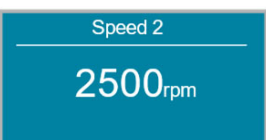
 <p>The LCD display shows the text 'Pump' at the top and 'off' below it, indicating the pump is not running.</p>	<p>Operation:</p> <p>Press the button 1 2 or 3 to select the preset fixed speed/performance level.</p> <p>If the pump starts from a standstill, it starts up in priming mode (in far as it is activated) and subsequently with the selected fixed speed/performance level.</p> <p>During operation the pump is started up to the fixed speed/performance level directly, without priming time.</p> <p>The motor is stopped by pressing the 0 button. If an analogue activation or RS485 is set in the parameters, the motor can be restarted with the 1 button.</p>
---	--

 <p>The LCD display shows 'Speed 2' at the top and '2500rpm' in the center, indicating the current speed setting.</p>	<p>Setting the speeds/performances:</p> <p>Press the button of the fixed speed/performance level that is to be changed (1 2 3) and then change the speed/ performance by using the ▼ ▲ buttons. The set speed/performance is stored directly and approached immediately when the fixed speed/performance level is selected again.</p>
--	--

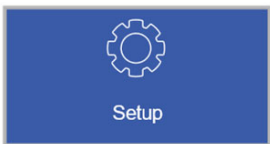
	<p>Notice: The speed/performance cannot be changed during the priming phase.</p>
---	---



	<p>Setting the parameters: You can change to the setup menu by pressing the S button for 3 seconds. There, you can scroll through the menu with the INFO button and change parameters and settings with the ▼▲ buttons.</p> <p>If the S button is pressed within the menu, all the changed values are stored and the setup menu exited. If you press the 0 button, the setup menu is exited without the changed values being stored.</p>
	

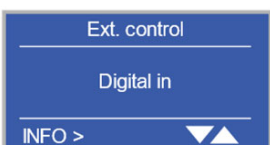

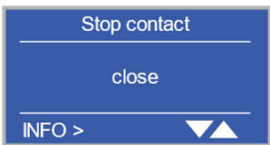
	<p>Language: The language can be set in the “Language” menu item. You can switch between languages with the ▼▲ buttons.</p> <p>The following languages can be selected:</p> <ul style="list-style-type: none"> • German • English • French • Italian • Dutch • Spanish
---	---

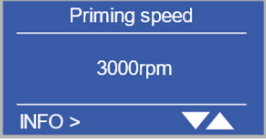
	<p>Digital and analogue inputs: The type of external activation can be determined in the “Ext. control” menu item.</p> <p>none = deactivated Digital in = digital inputs (potential-free) activated 0-10 V = analogue input 0-10 V 4-20 mA = analogue input 4-20 mA RS485 = Report on request</p>
--	--

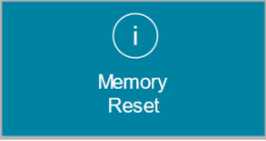
	<p>Switching behaviour stop contact: The switching behaviour of the digital input stop can be changed by using the menu item stop contact.</p> <p>Close means that the motor is stopped at a closed stop contact. Open means that the motor is stopped at an open stop contact. Without signal means that the external contact for stopping is not required. Opening the GND contact stops the motor.</p>
---	--

	<p>Suction parameters: Under the menu items “Suction time” and “Suction speed/power”, a time and speed/ power can be defined with which the pump sucks in the water and vents the pipe after a standstill.</p>
	

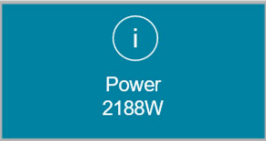
	<p>Resetting: The motor is reset to the factory setting when the  button is pressed for at least 10 seconds. The motor stops and “reset” is displayed.</p>
---	--

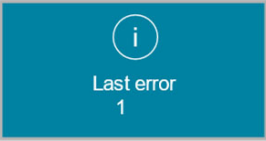
	<p>The current power requirement, the software version and the last error appear in the display on pressing the  button.</p>
	<p>The control unit's display switches off after five minutes without action.</p>
	

After a voltage drop the pump automatically starts up again with the speed last set, or remains stopped if it had been stopped beforehand.

The pump should be switched on and off by the control cable (potential-free) contacts provided, the analogue signal or RS485. This can be via a BADU Logic control, BADU OmniTronic or via a small coupling relay. This puts less stress on the electronics.

Overview of possible warnings and error messages

Warnings



Warnings indicate critical system states. They are displayed every ten seconds as long as there is no error. The currently measured temperature of the affected part (PCB board, PFC or IPM power module) is displayed at high temperatures. After a short time, the device is switched to the derating mode and the power is throttled. Derating is also displayed as a warning and overwrites previously displayed over temperature warnings.

Warning	Limit
PCB temperature high	>86 °C
PFC temperature high	>86 °C
IPM temperature high	>86 °C
Input voltage high	>255 V
Input voltage low	<206 V
Derating starts	See inverter parameters

Error type



Every error has an error reaction type, a number of repetitions of the reaction if the error persists and a wait time between the repetitions of the error (timeout).

Reaction type

Auto Try Again (ATA)	For general errors: The system automatically takes over an error reset every x seconds and tries to restore the last system state.
Wait on Action (WTA)	For critical errors: After an error reset by the user, the system restores the last system state.
Memory Reset (MR)	For errors in the parametrisation and initialisation: The memory is reset to factory settings and a system restart of the application board is made.
Bootloader Watchdog (BW)	For updating incompatible software: Running of the software is interrupted; a system update is necessary.

An error can be acknowledged and reset by long pressing (>3s) of the  button.

Error

No.	Error name	Reaction type	Number of reps.	Time-out
1	Under voltage	ATA	Infinite	5s
2	Over voltage	WTA	Infinite	5s
3	Wrong voltage at startup	ATA	1	10s
4	Over temperature power module	ATA	Infinite	60s
5	Over temperature motor	ATA	Infinite	60s
6	Over temperature PCB	ATA	Infinite	60s

No.	Error name	Reaction type	Number of reps.	Time-out
8	Over temperature PFC	ATA	Infinite	60s
98	Communication	ATA	Infinite	8s
100	Drive Initialisation	ATA	Infinite	15s
101	No external release	ATA	Infinite	30s
102	Motor start failed	WTA	Infinite	30s
103	Over current phase	WTA	1	5s
104	PFC undervoltage	WTA	Infinite	5s
105	Power module error	WTA	Infinite	5s
106	Power module passed on	WTA	Infinite	5s
107	Over current DCLink	WTA	Infinite	5s
200	HXIO Initialisation	MR	Infinite	30s
201	HXIO Parametrisation	MR	Infinite	30s
202	HXIO RT Application	ATA	Infinite	5s
210	HXIO Wrong HW-ID	BW	Infinite	0s
211	HXIO Wrong HW Version	BW	Infinite	10s
222	HXIO COM PM	ATA	Infinite	20s
223	HXIO COM PM Timeout	ATA	Infinite	20s
224	HXIO COM UI Timeout	ATA	Infinite	10s
225	HXIO COM SIO Timeout	ATA	Infinite	10s
230	HXIO EEPROM Error	ATA	Infinite	5s
231	HXIO EEPROM Error change block	ATA	1	5s

If an defect occurs, the system must be disconnected from the power supply. See chapter 2.2 of the original operating manual "non self-priming and self-priming pumps with/without plastic lanterns (AK version)".

The following points refer to the related documentation!

Installing or removing the cover/strainer basket

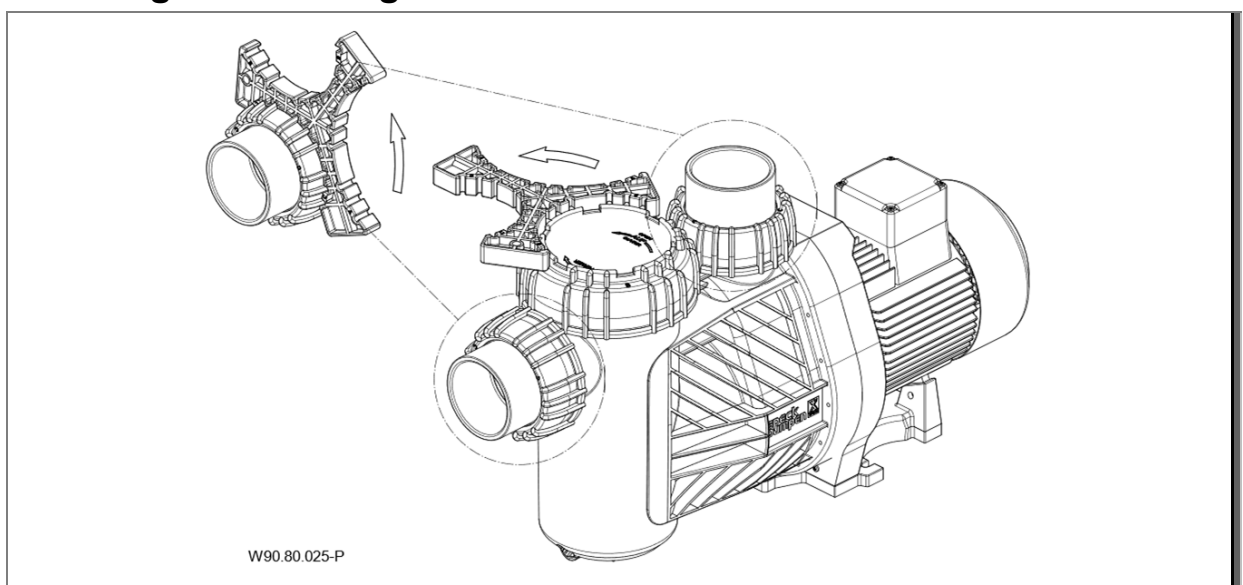

FR Fiche technique pompe

Documents applicables

Le présent document technique comprend la notice d'utilisation originale pour pompes non auto-amorçantes ou auto-amorçantes, avec/sans lanterne plastique (version AK). Il est recommandé de le tenir accessible aux personnes chargées de l'utilisation et de la maintenance.

BADU[®] Eco Flex

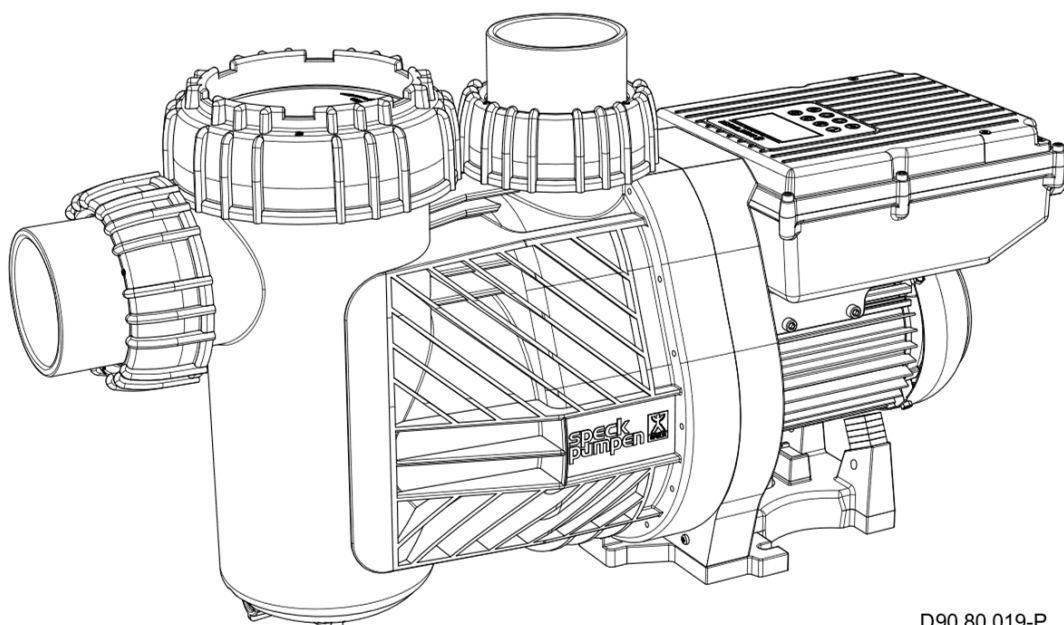

D90.80.019-P

Glossaire	
TD	Données techniques
Sa	Raccordement aspiration
Da	Raccordement refoulement
d-Saug	Diamètre recommandé conduite d'aspiration à 1 m
d-Druck	Diamètre recommandé conduite de refoulement à 1 m
max. L	Longueur maximale de la pompe
D	Densité
P ₁	Puissance électrique absorbée
P ₂	Puissance restituée
I	Intensité nominale
Lpa (1 m)	Niveau de pression acoustique à un mètre de distance. Mesures effectuées conformément à DIN 45635
Lwa	Intensité sonore
m	Poids
WSK	Disjoncteur thermique intégré dans le bobinage ou disjoncteur de protection moteur
PTC	Thermistor PTC
H _{max.}	Hauteur manométrique maximale
SP	Auto-amorçante
Hs; Hz	Hauteur géodésique entre le niveau d'eau et la pompe
Hs	Hauteur d'aspiration maximale
Hz	Hauteur maximale en alimentation
IP	Classe de protection
W-KI	Classe d'isolement
n	Vitesse de rotation
P-GHI	2,5 bar de pression maximale à l'intérieur du carter/ pression maximale de l'équipement
T	Température de l'eau
●	Oui
○	Non
T/°C	Informations sur la température de l'eau 40 °C (60 °C): 40 °C = valable pour une température maximale en conformité avec le sigle GS. (60 °C) = Cependant, la pompe est facilement utilisable/ étalonnée pour une température maximale de l'eau de 60 °C
1~/3~	Adaptée pour un fonctionnement continu à 1~ 220 - 240 V ± 5% 3~ Y/Δ 380 - 420 V/220 - 240 V ± 5% 3~ Y/Δ 660 - 725 V/380 - 420 V ± 5% Appropriée à une tension conforme aux normes DIN IEC 60038; DIN EN 60034

La pompe possède un moteur à entraînement électromagnétique avec protection contre la surcharge.

Raccordement des contacts de commande externe

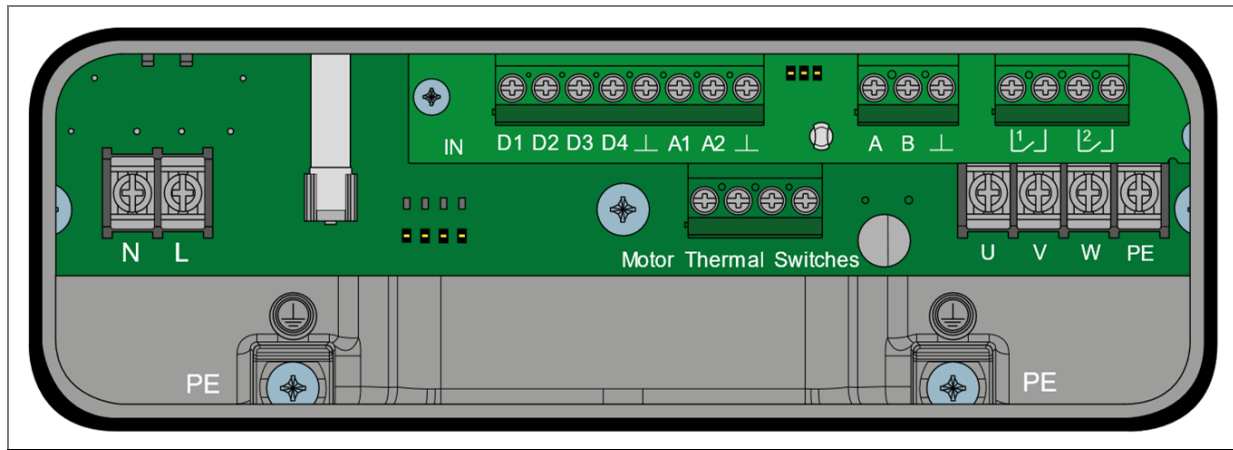

Type	Borne	Description
Alimentation secteur	L	1~ 230 V 50/60 Hz
	N	
	PE	Conducteur de protection
Entrées numériques (sans potentiel)	D1	Brun = n1
	D2	Vert = n2
	D3	Blanc = n3
	D4	Rouge = Arrêt
	⊥	Arrêt = GND
Entrées analogiques	A1	0-10 V
	A2	4-20 mA
	⊥	GND
RS485	A	RS485+
	B	RS485-
	⊥	GND
Relais	1	Affichage de l'état du moteur max. 5 A-250 V CA/5 A-30 V CC
	2	
Thermorupteurs du moteur	PTC1	Gris – Gris
	PTC2	Blanc – Blanc
Raccord du moteur	U	Brun
	V	Bleu
	W	Noir
	PE	Vert/jaune

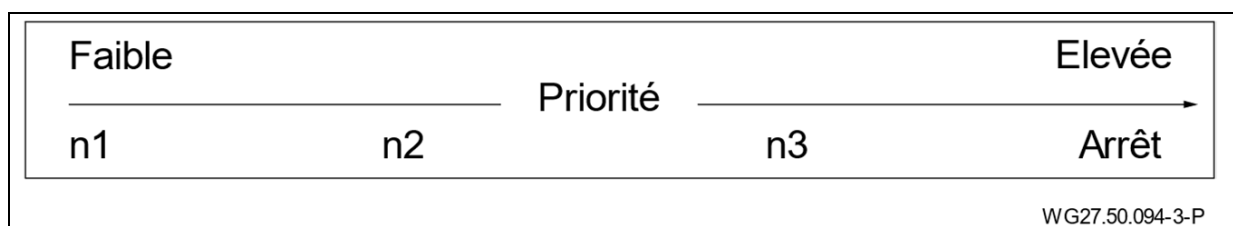

WG27.50.094-3-P

Affichage de l'état du moteur via les relais 1 et 2

Le relais 1 se ferme dès que le moteur est alimenté avec la tension de secteur et qu'aucune erreur n'a été détectée. En présence d'une erreur, le relais 1 se rouvre. Le relais 2 se ferme dès que le moteur tourne.

Cet affichage de l'état du moteur n'offre pas une sécurité à 100 %, celle-ci est uniquement garantie en cas d'utilisation d'un capteur de débit ou de pression.

Comportement de commutation signal analogique

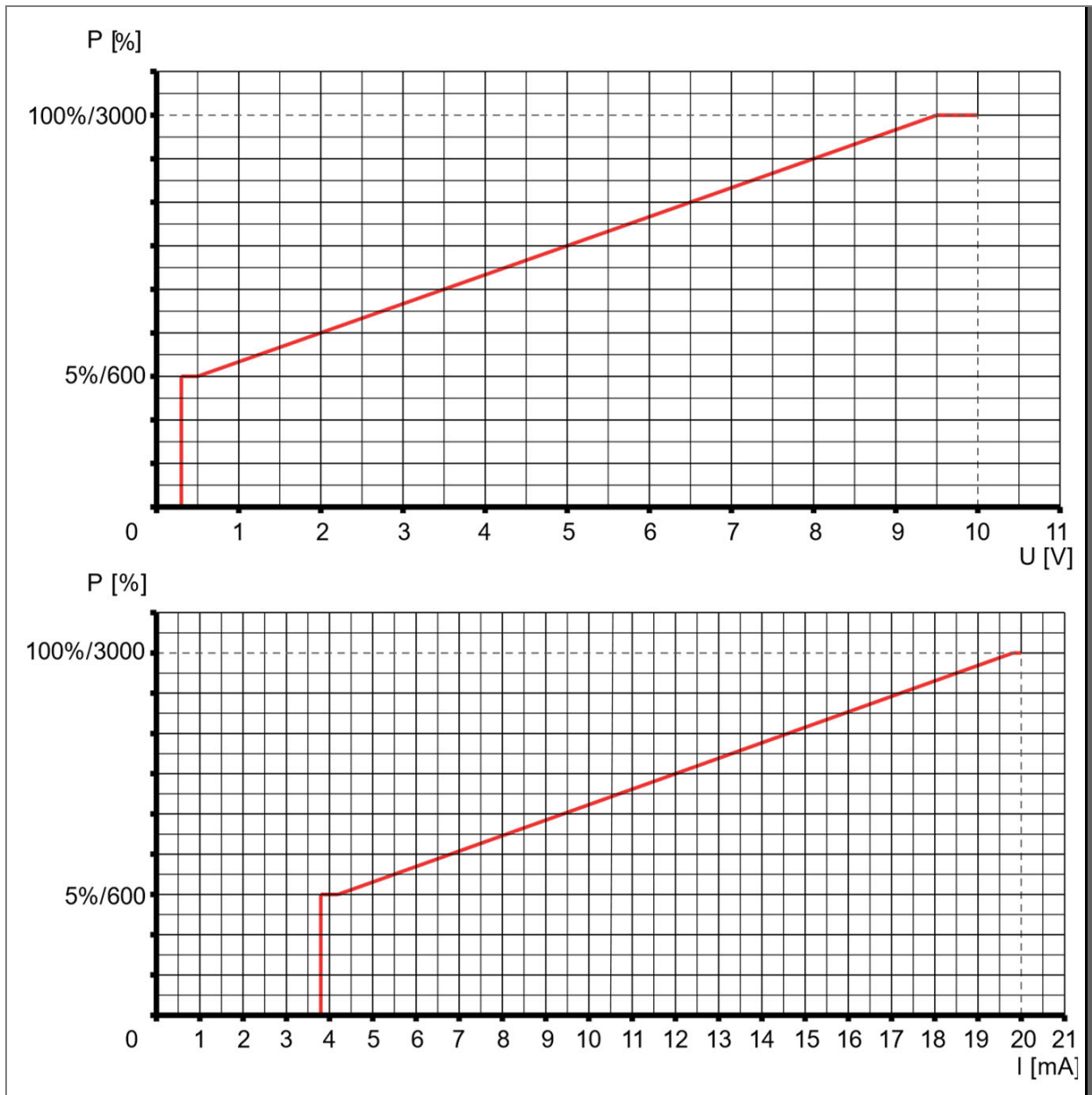

AVIS

Activation de la vitesse du moteur au moyen d'un interrupteur manuel ou de contacts de commutation externes. Ceci active les contacts de commutation et la vitesse assignée.

Si la pompe démarre à partir de l'arrêt, elle démarre en mode d'aspiration puis bascule à la vitesse de rotation fixe sélectionnée, exception faite de l'activation analogique 0-10 V, 4-20 mA et RS485.

En cours de fonctionnement, les vitesses de rotation fixes sont atteintes directement, sans temps d'amorçage.

Lorsque la commande externe n'est pas utilisée, les extrémités des câbles doivent être isolées.

AVIS

Pour la parfaite interaction avec des périphériques tels que les échangeurs de chaleur électriques ou les installations de dosage, le montage d'un contrôleur de débit avec une unité d'évaluation correspondante est recommandé. L'émission d'un message d'anomalie est également possible.

AVIS

Pour éviter des dysfonctionnements dans le moteur, tenir obligatoirement compte des points suivants :

- Le câble d'alimentation du boîtier de commande doit être correctement posé. Eviter tout montage parallèle à tout autre câble d'alimentation.
 - Si le câble du boîtier de commande devait être prolongé, cela pourrait impliquer des variations de tensions dangereuses sur l'entrée numérique. Ceci peut être évité, par exemple, par blindage.
 - Ne pas faire fonctionner différents appareils sur la même ligne d'alimentation.
-

Sélection du mode de fonctionnement

Avec ce moteur, il est possible de distinguer entre deux modes de fonctionnement (modes). La régulation du moteur est possible soit par le biais de la vitesse de rotation soit par le biais de la puissance.

Le mode « Vitesse de rotation constante » permet de configurer la vitesse de rotation souhaitée sur le moteur et de maintenir cette vitesse de rotation en permanence au-dessus de la courbe caractéristique.

Le mode « Puissance constante » permet de configurer la puissance souhaitée en % sur le moteur et de la maintenir en permanence au-dessus de la courbe caractéristique.

Elle est maintenue constante sur la courbe de performances.

Mode	Vitesse de rotation constante *	Puissance constante
Préréglage:		
Vitesse de rotation/ Puissances:	1 = 2000 min ⁻¹ 2 = 2500 min ⁻¹ 3 = 3000 min ⁻¹	1 = 60 % 2 = 80 % 3 = 100 %
Vitesse d'amorçage / Puissance d'amorçage : Temps d'amorçage :	= 3000 min ⁻¹ = 5 minutes	= 100 % = 5 minutes
Vitesse de rotation/ Puissances réglables :	600 – 3000 min ⁻¹ (par pas de 10 min ⁻¹)	5 – 100 % (par pas de 1 %)
Temps d'amorçage réglable :	arrêt, 1 – 10 min. (par pas de 1 min.)	arrêt, 1 – 10 min. (par pas de 1 min.)
Langue	english	english
Commande externe:	aucune	aucune

* La fonction <<Vitesse de rotation constante>> correspond au réglage d'usine.

Structure du menu Setup

En fonction de la sélection ou de la configuration, les rubriques du menu sont affichées ou masquées selon le diagramme suivant.

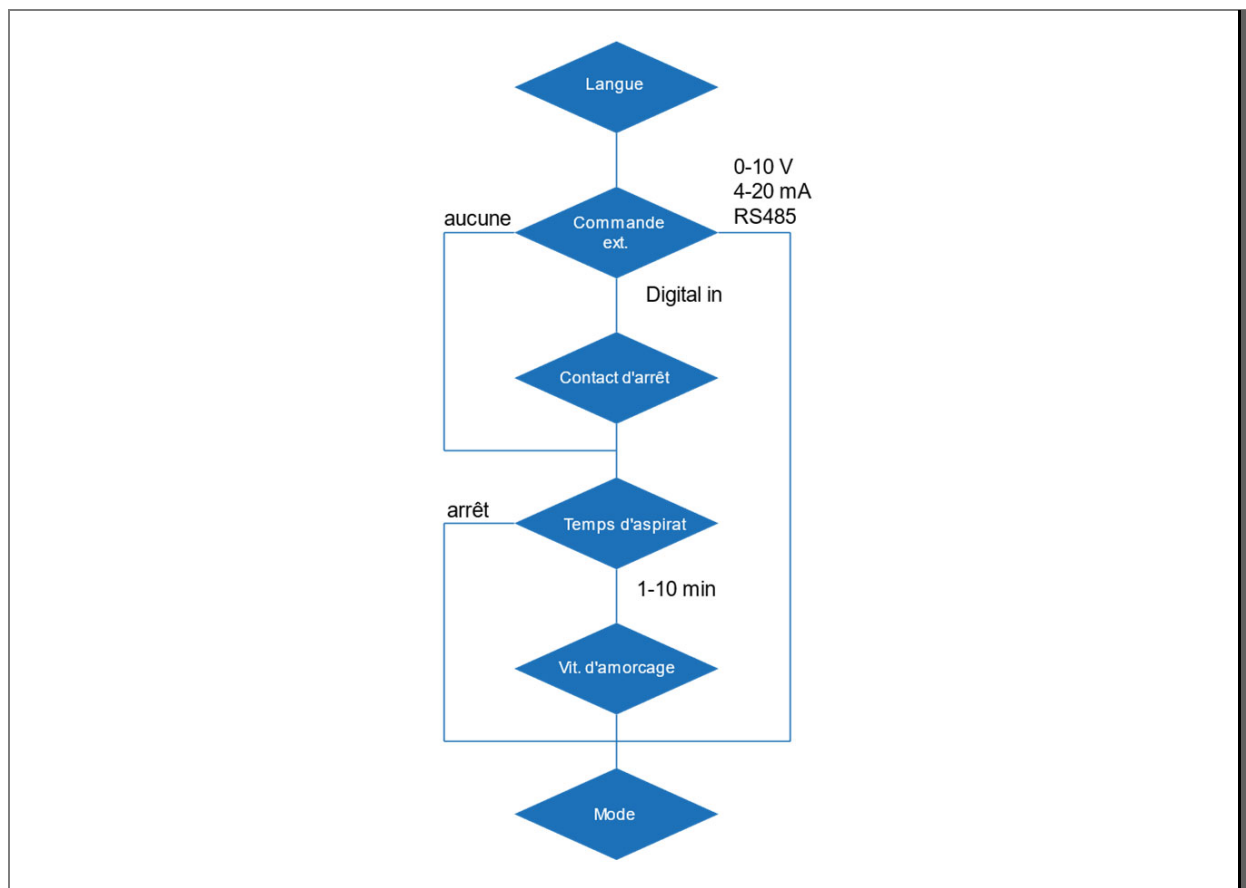



	<p>Interface de commande:</p> <p>(1) Afficheur LCD: indique la vitesse de rotation/la puissance actuelle du moteur.</p> <p>(2) 1 2 3 : sélection des vitesses de rotation/puissances prédéfinies</p> <p>(3) INFO : pour l'affichage de la consommation instantanée et la sélection des points de menu dans le setup</p> <p>(4) S : pour régler les paramètres</p> <p>(5) ▼ ▲ : pour modifier la vitesse de rotation/puissance/paramètres</p> <p>(6) 0 : pour arrêter le moteur</p>
--	---

	<p>Commande:</p> <p>Appuyer sur la touche 1 2 ou 3 pour sélectionner la vitesse de rotation/la puissance prédéfinie. Lorsque la pompe démarre à partir de l'arrêt, elle démarre en mode amorçage (pour autant que celui-ci soit activé) et ensuite à la vitesse de rotation/la puissance fixe sélectionnée. En cours de fonctionnement, les vitesses de rotation/la puissance sont atteintes directement, sans temps d'amorçage. En appuyant sur la touche 0, le moteur est arrêté. Lorsqu'une activation analogique ou RS485 est configurée dans les paramètres, le moteur peut être redémarré en appuyant sur la touche 1.</p>
--	---

	<p>Réglage des vitesses de rotation/ puissance:</p> <p>Appuyer sur la touche de la vitesse de rotation/la puissance fixe qui doit être modifiée (1 2 3) et ensuite modifier la vitesse de rotation/la puissance avec les touches ▼ ▲. La vitesse de rotation/la puissance réglée est directement enregistrée et atteinte directement en cas de nouvelle sélection de la vitesse de rotation fixe/la puissance.</p>
--	---

	<p>Indication: Pendant la phase d'aspiration, la vitesse de rotation/la puissance ne peut pas être modifiée.</p>
--	---



	<p>Réglage des paramètres: En appuyant sur la touche S pendant 3 secondes, on passe au menu Setup. Une pression sur la touche INFO permet ici de faire défiler le menu et sur les touches ▼ ▲ de modifier les paramètres et réglages. Si on appuie sur la touche S dans le menu, toutes les valeurs modifiées sont enregistrées et on quitte le menu Setup. En appuyant sur la touche 0, on quitte le menu Setup sans enregistrement des valeurs modifiées.</p>
	

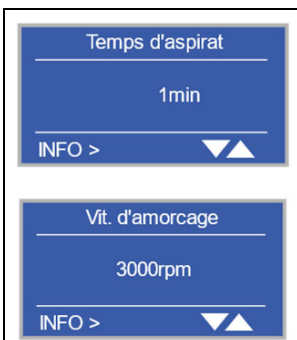

	<p>Langue : La rubrique du menu « Langue » permet de choisir la langue. Les touches ▼ ▲ permettent de basculer entre les différentes langues. Les langues suivantes peuvent être sélectionnées :</p> <ul style="list-style-type: none"> • Allemand • Anglais • Français • Italien • Néerlandais • Espagnol
---	--

	<p>Entrées numériques et analogiques : La rubrique du menu « Commande ext. » permet de définir le type d'activation externe.</p> <p>aucune = désactivée Digital in = entrées numériques (libres de potentiel) activées 0-10 V = Entrée analogique 0-10 V 4-20 mA = Entrée analogique 4-20 mA RS485 = Protocole sur demande</p>
---	---

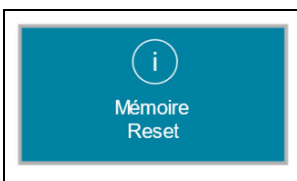
	<p>Comportement de commutation contact d'arrêt: Sous le point contact d'arrêt, le comportement de commutation de l'entrée numérique arrêt peut être modifié.</p> <p>Fermer signifie que le moteur s'arrête lorsque le contact STOP est fermé. Ouvrir signifie que le moteur s'arrête lorsque le contact STOP est ouvert. Sans signal signifie que le contact externe n'est pas requis pour stopper. Si on ouvre le contact GND, le moteur s'arrête.</p>
---	--

	<p>Paramètres d'aspiration : Les rubriques du menu « Durée d'aspiration » et « Vitesse/capacité d'aspiration » permettent de configurer une durée et une vitesse ou capacité avec lesquelles la pompe aspire l'eau après un arrêt puis purge la conduite.</p>
---	---

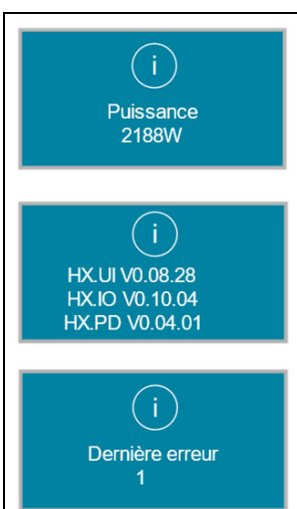
	<p>Réinitialiser / Reset: Si on appuie sur la touche  pendant au moins 10 secondes, le variateur est réinitialisé aux réglages d'usine. Le moteur s'arrête et l'écran affiche « reset ».</p>
---	---

	<p>Une pression sur la touche  affiche la consommation de puissance actuelle, la version du logiciel et la dernière erreur sur l'écran.</p> <p>L'écran de la commande s'éteint après 5 minutes sans action.</p>
--	--

Après une coupure de tension, la pompe tourne automatiquement à nouveau avec la vitesse de rotation réglée en dernier lieu ou reste à l'arrêt si elle avait été préalablement stoppée.

La mise en marche ou à l'arrêt de la pompe devrait être réalisée par le biais du câble de commande prévu à cet effet (contacts sans potentiel), du signal analogique ou de RS485. Ceci peut être effectué par le biais d'une commande BADU-Logic, BADU OmniTronic ou par le biais d'un petit relais de couplage. L'électronique est ainsi moins sollicitée.

Vue d'ensemble des avertissements et messages d'erreur possibles

Avertissements



Les avertissements attirent l'attention sur des états limites du système. Ils sont affichés toutes les dix secondes tant qu'aucune erreur n'est détectée. En présence de hautes températures, la température actuellement mesurée sur composant concerné (platine PCB, module de puissance PFC ou IPM) est affichée. Après un certain temps, l'appareil bascule en

mode Réduction de puissance et la puissance est limitée. Réduction de puissance est également affiché en guise d'avertissement et écrase les avertissements de surchauffe préalablement affichés.

Avertissement	Valeur limite
Température PCB élevée	> 86 °C
Température PFC élevée	> 86 °C
Température IPM élevée	> 86 °C
Tension d'entrée élevée	> 255 V
Basse tension d'entrée	< 206 V
Démarrages réduction de puissance	Voir Paramètres de l'onduleur

Type d'erreur



Chaque erreur possède un type de réaction d'erreur, un nombre de répétitions de la réaction si l'erreur persiste et un temps d'attente entre les répétitions de l'erreur (timeout).

Type de réaction

Auto Try Again (ATA)	Pour les erreurs générales : le système active automatiquement une réinitialisation des erreurs toutes les x secondes et tente de restaurer le dernier état du système.
Wait on Action (WTA)	Pour les erreurs critiques : après une réinitialisation des erreurs par l'utilisateur, le système tente de restaurer le dernier état du système.
Memory Reset (MR)	Pour les erreurs pendant le paramétrage et l'initialisation : les réglages d'usine sont restaurés sur la mémoire et le système de la carte d'application redémarre.
Bootloader Watchdog (BW)	Pour la mise à jour de logiciels incompatibles : l'exécution du logiciel est arrêtée, une mise à jour du système est obligatoire.

Une pression prolongée (> 3 s) sur la touche  permet d'acquiescer et de réinitialiser une erreur.

Erreur

N°	Nom de l'erreur	Type de réaction	Nbre de répétitions	Time-out
1	Sous tension	ATA	Illimité	5s
2	Surtension	WTA	Illimité	5s
3	Tension incorrecte au démarrage	ATA	1	10s
4	Surchauffe du module de puissance	ATA	Illimité	60s
5	Surchauffe du moteur	ATA	Illimité	60s
6	Surchauffe PCB	ATA	Illimité	60s
8	Surchauffe PFC	ATA	Illimité	60s
98	Communication	ATA	Illimité	8s
100	Initialisation de l'entraînement	ATA	Illimité	15s
101	Aucun déclenchement externe	ATA	Illimité	30s
102	Échec du démarrage du moteur	WTA	Illimité	30s
103	Phase de surintensité de courant	WTA	1	5s
104	Sous-tension PFC	WTA	Illimité	5s
105	Erreur du module de puissance	WTA	Illimité	5s
106	Transmission du module de puissance	WTA	Illimité	5s
107	Surintensité de courant DCLink	WTA	Illimité	5s
200	Initialisation HXIO	MR	Illimité	30s
201	Paramétrage HXIO	MR	Illimité	30s
202	HXIO RT Application	ATA	Illimité	5s
210	ID matériel HXIO incorrecte	BW	Illimité	0s
211	Version matériel HXIO incorrecte	BW	Illimité	10s
222	HXIO COM PM	ATA	Illimité	20s
223	HXIO COM PM Timeout	ATA	Illimité	20s
224	HXIO COM UI Timeout	ATA	Illimité	10s
225	HXIO COM SIO Timeout	ATA	Illimité	10s
230	Erreur EEPROM HXIO	ATA	Illimité	5s
231	Erreur changer bloc EEPROM HXIO	ATA	1	5s

En cas de défaut, l'installation doit être isolée de l'alimentation électrique. Cf. chapitre 2.2 de la notice d'utilisation originale pour pompes non auto-

amorçantes ou autoamorçantes avec/sans lanterne plastique (exécution AK).

Les énumérations suivantes se rapportent aux documents d'accompagnement!

Monter/démonter le couvercle/le panier filtrant

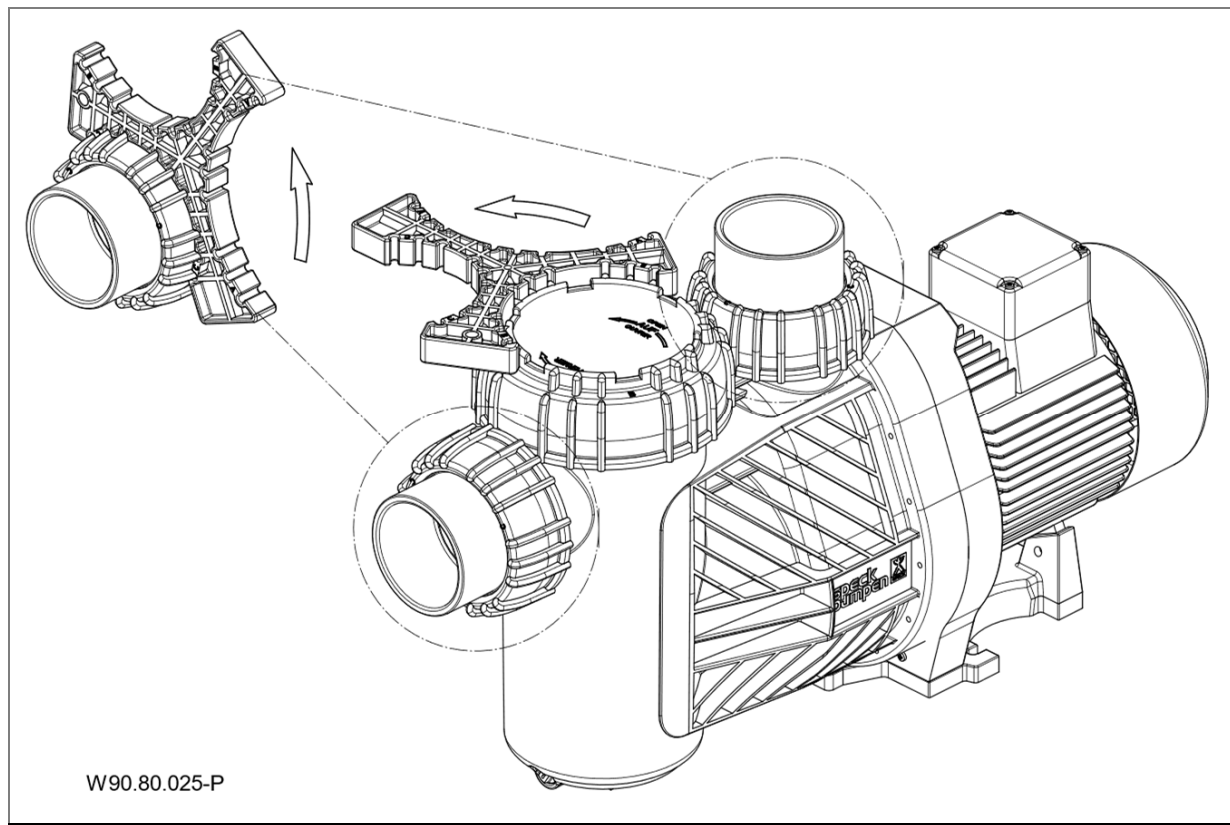

NL Pompgegevens

Relevante documenten

Bij deze pompgegevens hoort de originele gebruiksaanwijzing "normal en zelfaanzuigende pompen met/zonder kunststof lantaarn (AK)". Deze moet voor het bedienings- en onderhoudspersoneel te allen tijde beschikbaar zijn.

BADU[®] Eco Flex

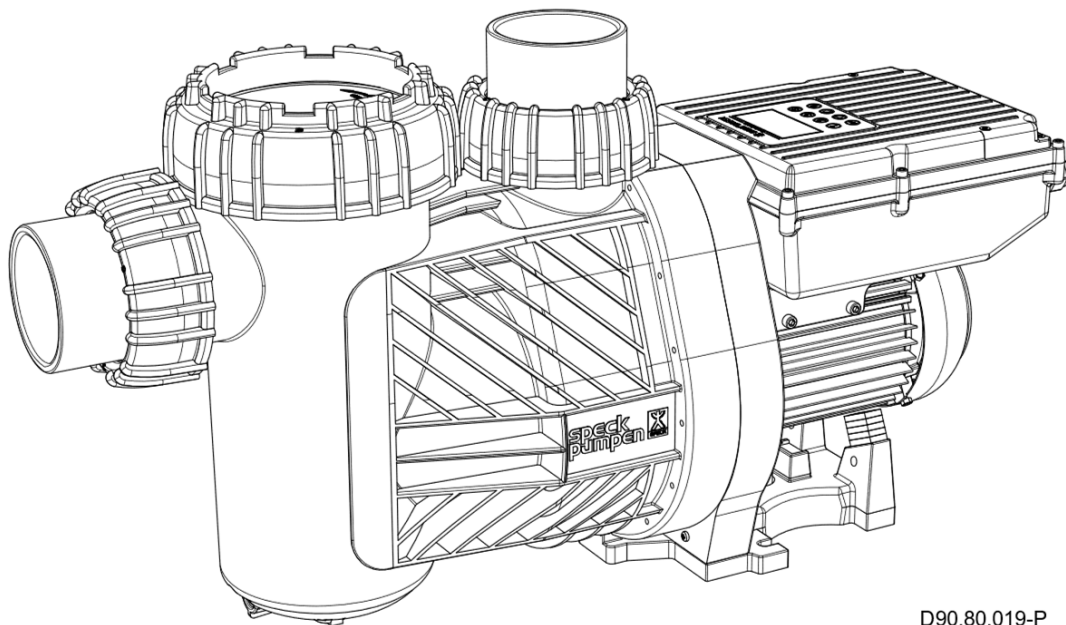

D90.80.019-P

Woordenlijst	
TD	Technische gegevens
Sa	Zuigaansluiting
Da	Persaansluiting
d-Saug	Aanbevolen diameter van de zuigleiding vanaf 5 m
d-Druck	Aanbevolen diameter van de persleiding vanaf 5 m
max. L	Maximale lengte van de pomp
D	Soortelijke massa
P ₁	Opgenomen vermogen
P ₂	Afgegeven vermogen
I	Nominale stroom
L _{pa} (1 m)	Geluidsniveau gemeten bij 1 m. afstand volgens DIN 45635
L _{wa}	Geluidsniveau
m	Gewicht
WSK	Wikkelingsbeschermingscontact of motorbeveiligingsschakelaar
PTC	PTC-voeler
H _{max.}	Maximale opvoerhoogte
SP	Zelfaanzuigend
H _s ; H _z	Geodetische hoogte tussen het waterniveau en de pomp
H _s	Maximale zuighoogte
H _z	Maximale hoogte bij toeloopbedrijf
IP	Beschermingsklasse
W-KI	Temperatuurklasse
n	Toerental
P-GHI	2,5 bar maximale huisdruk/maximale systeemdruk
T	Watertemperatuur
●	Ja
○	Nee
T/°C	Verklaring watertemperatuur 40 °C (60 °C): 40 °C = max. watertemperatuur in combinatie met het GS-keurmerk. (60 °C) = de pomp is geschikt voor een max. watertemperatuur van 60 °C
1~/3~	Geschikt voor continu gebruik bij 1~ 220 - 240 V ± 5% 3~ Y/Δ 380 - 420 V/220 - 240 V ± 5% 3~ Y/Δ 660 - 725 V/380 - 420 V ± 5% Voor normspanning volgens DIN IEC 60038; DIN EN 60034

De pomp is voorzien van een motor met permanente magneet en is elektronisch beveiligd tegen overbelasting.

Aansluiting van externe schakelcontacten

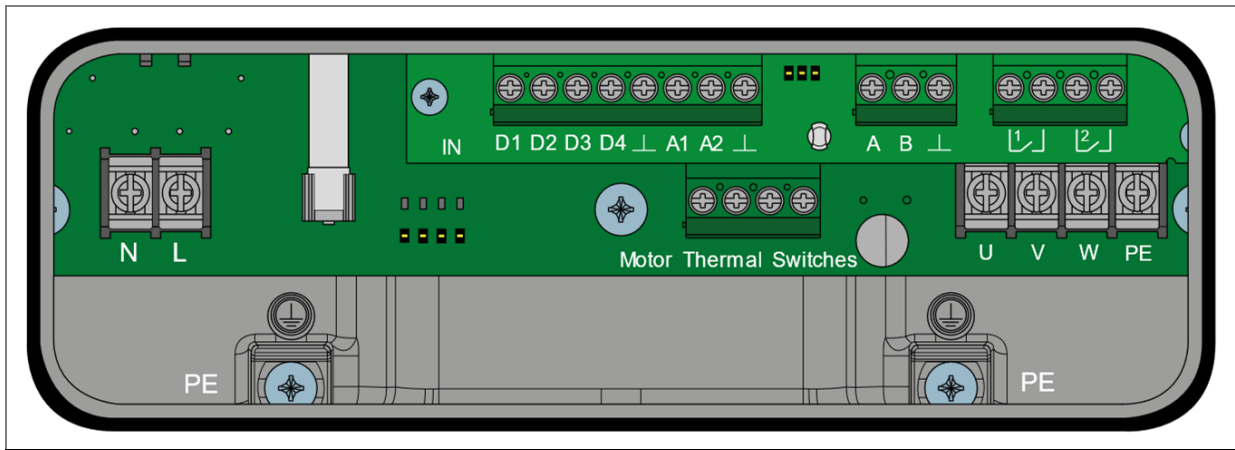

Type	Klem	Beschrijving
Netaansluiting	L	1~ 230V 50/60 Hz
	N	
	PE	Aardleider
Digitale ingangen (potentiaalvrij)	D1	Bruin = n1
	D2	Groen = n2
	D3	Wit = n3
	D4	Rood = stop
	⊥	Zwart = GND
Analoge ingangen	A1	0-10 V
	A2	4-20 mA
	⊥	GND
RS485	A	RS485+
	B	RS485-
	⊥	GND
Relais	1	Motortoestandsindicatie max. 5A- 250 V AC/5 A-30 V DC
	2	
Motorbeveiligingsschakelaars	PTC1	Grijs - grijs
	PTC2	Wit - wit
Matoraansluiting	U	Bruin
	V	Blauw
	W	Zwart
	PE	Groen/geel



WG27.50.094-4-P

Motortoestandsindicatie via relais 1 en 2

Relais 1 sluit zodra de motor wordt gevoed met netspanning en er geen fout is. Bij een fout opent relais 1 weer. Relais 2 sluit, zodra de motor loopt.

Deze indicatie van de motortoestand biedt geen 100% zekerheid, dit wordt alleen door een stromings- of druksensor gewaarborgd.

Schakelgedrag analogoog signaal

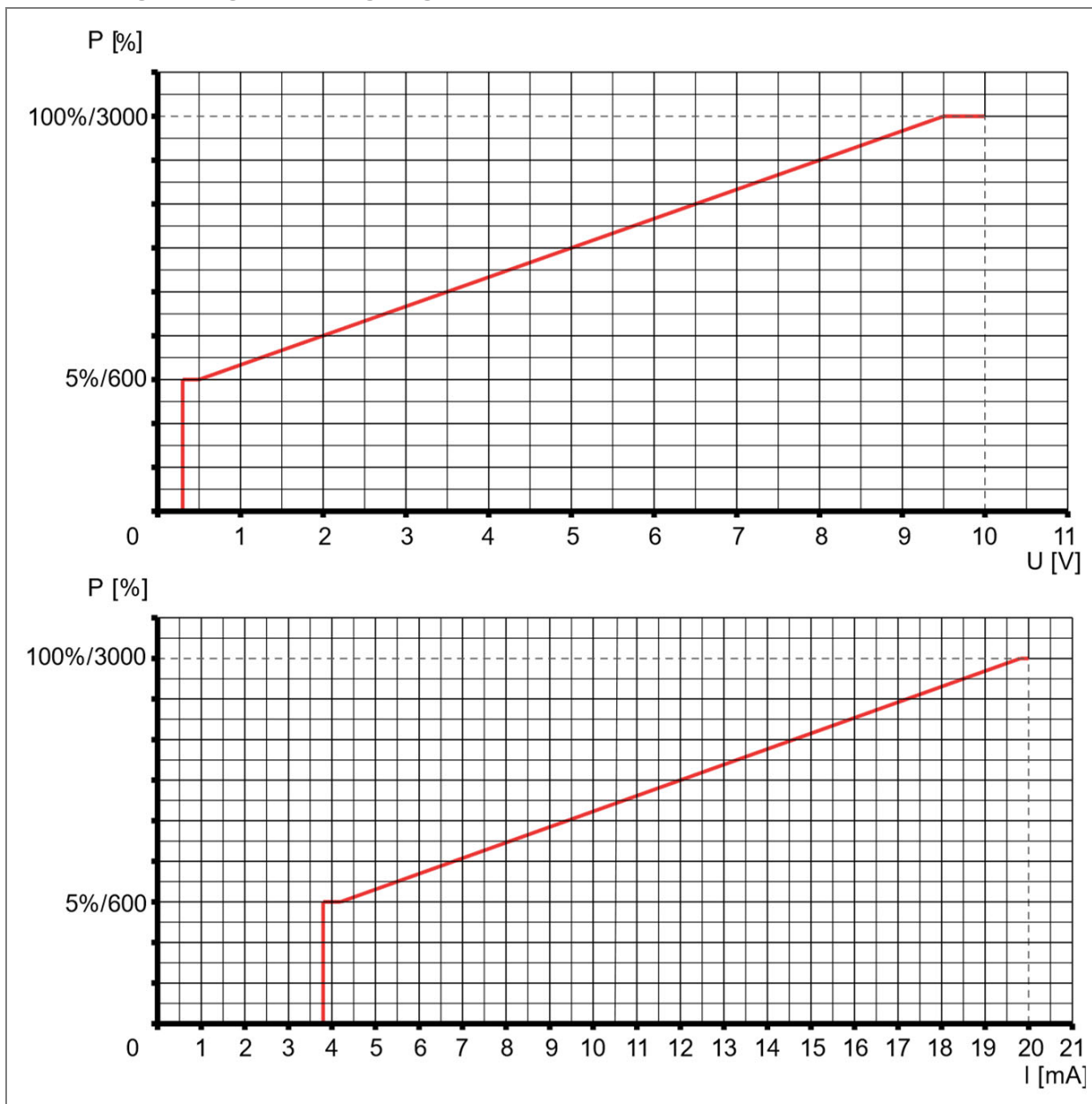

LET OP

Inschakelen van de motor met de handschakelaar of met externe schakelcontacten. Daardoor wordt het betreffende schakelcontact en het toegewezen toerental geactiveerd.

Start de pomp vanuit stilstand, start hij op in de aanzuigmodus en daarna met het geselecteerde vaste toerental, met uitzondering van de analoge aansturing 0-10 V, 4-20 mA en RS485.

Wanneer de pomp al in bedrijf is, gaat deze direct naar de vaste toerentallen, zonder aanzuigtijd.

Wanneer externe aansturing niet nodig is, moeten de uiteinden van de kabel worden geïsoleerd.

LET OP

Voor een probleemloos samenspel met randapparatuur, bijv. elektrische warmtewisselaars of doseerinstallaties, wordt het inbouwen van een stromingsbewaking met bijbehorende analyse-eenheid aanbevolen. Hiermee kan ook een storingsmelding worden gegeven.

LET OP

Om stringen in de motor te voorkomen, moet altijd op de volgende punten gelet worden:

- De bedieningskabel moet professioneel correct aangelegd zijn. Een montage parallel naar een eigen netleiding of van andere consumenten moet voorkomen worden.
 - Indien de bedieningskabels verlengd worden, kunnen gevaarlijke spanningen aan de digitale ingang ontstaan. Dit moet bijvoorbeeld door afscherming voorkomen worden.
 - De stroomkabel van verschillende apparaten niet op dezelfde stroombron aansluiten.
-

Keuze van de bedrijfsmodus

Bij deze motor kan worden gekozen uit twee bedrijfsmodi (modi). De motor kan via het toerental of via de capaciteit worden geregeld.

Bij de modus "Constant toerental" wordt het gewenste toerental bij de motor ingesteld en wordt dit toerental via de karakteristiek constant gehouden.

Bij de modus "Constante capaciteit" wordt de gewenste capaciteit in % bij de motor ingesteld en wordt dit over de gehele karakteristiek constant gehouden. De motor regelt hierbij het toerental automatisch op basis van de ingestelde capaciteit.

Modus	Constant toerental *	Constance capaciteit
Standaardinstelling: Toerental/Capaciteit:	1 = 2000 min ⁻¹ 2 = 2500 min ⁻¹ 3 = 3000 min ⁻¹	1 = 60 % 2 = 80 % 3 = 100 %
Aanzuigtoerental/ Aanzuigcapaciteit: Aanzuigtijd:	= 2850 min ⁻¹ = 5 minuten	= 100 % = 5 minuten
Instelbare toerental/ capaciteiten:	600 – 3000 min ⁻¹ (<i>in stappen van 10 min⁻¹</i>)	5 – 100 % (<i>in stappen van 1 %</i>)
Instelbare aanzuigtijd:	uit, 1 – 10 min. (<i>in stappen van 1 Min.</i>)	uit, 1 – 10 min. (<i>in stappen van 1 Min.</i>)
Taal	english	english
Externe aansturing:	geen	geen

* De functie „constant toerental“ is de fabriekinstelling.

Menustructuur setup

Afhankelijk van de keuze, resp. instelling worden menupunten volgens het volgende schema weergegeven of verborgen.

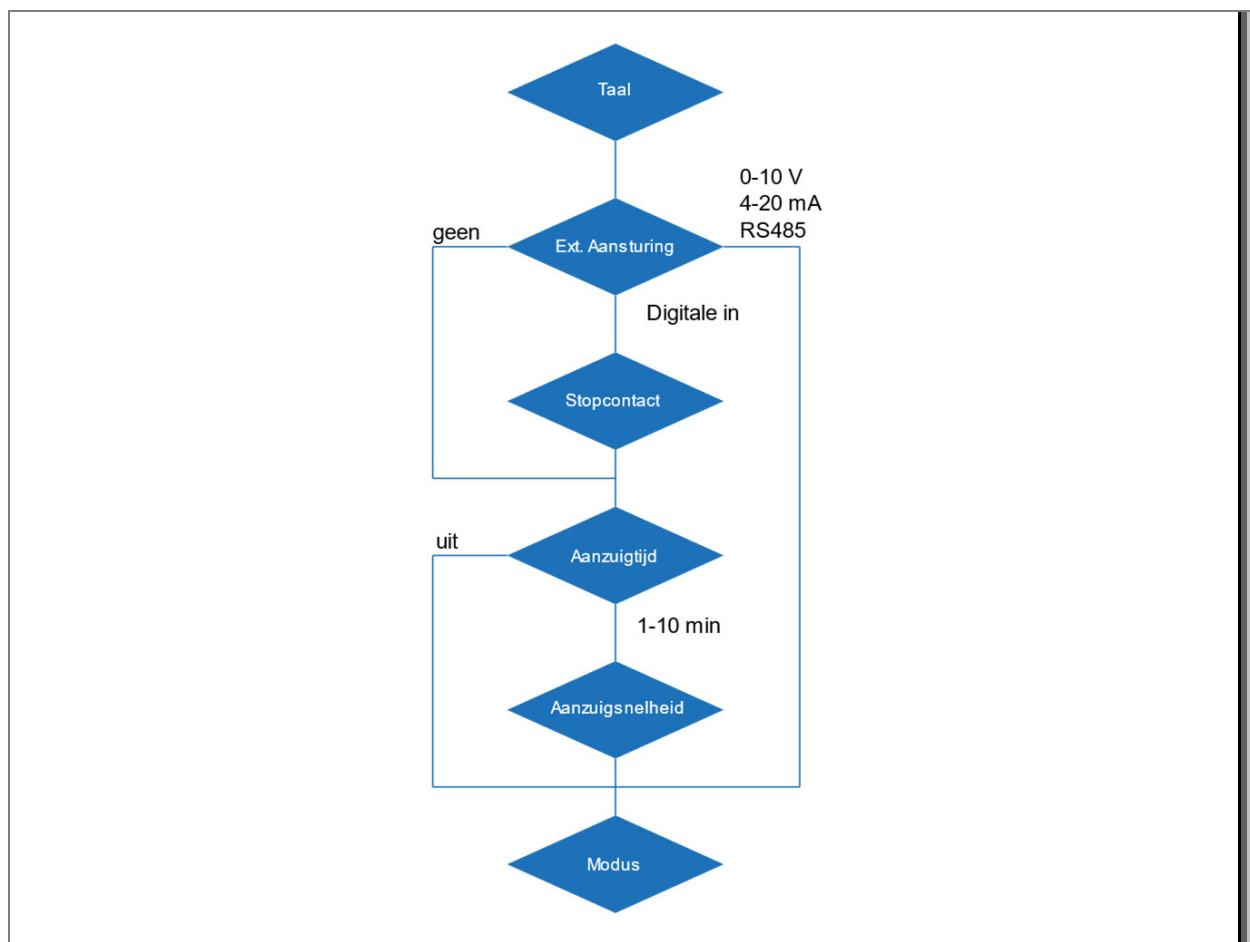

	<p>Bedieningsinterface:</p> <p>(1) LCD-display: geeft het huidige toerental/capaciteit van de motor aan.</p> <p>(2) 1 2 3: keuze uit de vooraf ingestelde toerentallen/capaciteitsniveau.</p> <p>(3) INFO: voor weergave van het huidige verbruik en keuze van de menu items in setup.</p> <p>(4) S: voor het instellen van parameters</p> <p>(5) ▼ ▲: voor het wijzigen van het toerental/capaciteit/parameters</p> <p>(6) 0: om de motor te stoppen</p>
--	--

	<p>Bediening:</p> <p>Druk op toets 1 2 of 3 om het vooraf ingestelde toerental/capaciteit te selecteren.</p> <p>Wanneer de pomp start vanuit stilstand, loopt deze aan in de aanzuigstand (voor zover deze is geactiveerd) en aansluitend met het geselecteerde vaste toerental/capaciteitsniveau.</p> <p>Wanneer de pomp al in bedrijf is, gaat deze direct naar het geselecteerde toerental/capaciteitsniveau, zonder aanzuigtijd.</p> <p>Met de toets 0 wordt de motor gestopt. Is in de parameters een analoge aansturing of RS485 ingesteld, kan de motor weer worden gestart met de toets 1.</p>
--	---

	<p>Instellen van de toerentallen/capaciteits:</p> <p>Druk op de toets van het vaste toerental/capaciteitsniveau dat moet worden gewijzigd (1 2 3) en wijzig vervolgens met de toetsen ▼ ▲ het toerental/capaciteit. Het ingestelde toerental/capaciteit wordt direct opgeslagen en toegepast wanneer opnieuw het vaste toerental/capaciteitsniveau wordt geselecteerd.</p>
--	---

	<p>Aanwijzing: Tijdens de aanzuigfase kan het toerental/ capaciteit niet worden gewijzigd.</p>
--	---

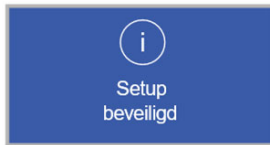

Instellen van parameters:

Door gedurende 3 seconden op de **S**-toets te drukken, wordt het setup-menu geopend. Daar kan met de **INFO**-toets door het menu worden gebladerd en met de toetsen **▼** **▲** parameters en instellingen worden gewijzigd.

Wanneer in het menu op de toets **S** wordt gedrukt, worden alle gewijzigde waarden opgeslagen en wordt het setup-menu verlaten. Met de toets **0** wordt het setup-menu verlaten zonder de gewijzigde waarden op te slaan.



Taal:

Bij het menupunt "Taal" kan de taal worden ingesteld. Via de toetsen **▼** **▲** kan worden opgeschakeld tussen de talen.

De volgende talen kunnen worden geselecteerd:

- Duits
- Engels
- Frans
- Italiaans
- Nederlands
- Spaans



Digitale en analoge ingangen:

Bij het menupunt " Ext. Aansturing " kan het type externe aansturing worden vastgelegd.

geen = gedeactiveerd

Digitale in = digitale ingangen (potentiaalvrij) geactiveerd

0-10 V = analoge ingang 0-10 V

4-20 mA = analoge ingang 4-20mA

RS485 = Protocol op aanvraag



Schakelgedrag stopcontact:



Onder menuonderdeel stopcontact kan het schakelgedrag van digitale ingang stop worden gewijzigd.



Sluiten betekent dat de aandrijving wordt gesloten als het stop contact/verbinding gesloten is.

Open betekent dat de aandrijving gesloten is wanneer het stop contact/verbinding open is.

Zonder Signaal betekent dat het externe contact om te stoppen niet nodig is. Het verbreken van het GND-contact stopt de aandrijving..

	<p>Aanzuigparameters: Bij de menupunten "Aanzuigtijd" en "Aanzuigtoerental/-capaciteit" kan een tijd en toerental/capaciteit worden gedefinieerd, waarmee de pomp na een stilstand het water aanzuigt en de pijpleiding ontlucht.</p>
---	---

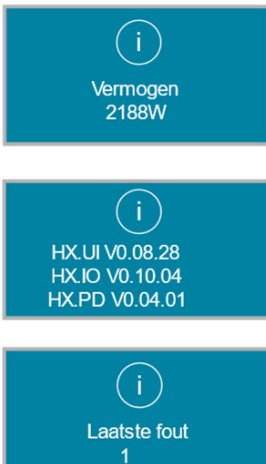
	<p>Resetten: Wanneer gedurende ten minste 10 seconden op de  -toets wordt gedrukt, wordt de aan-drijving gereset naar de standaardinstelling. De motor stopt en op het display staat "reset".</p>
---	--

	<p>Door drukken op de  -toets wordt op het display de actuele capaciteitsvraag, de softwareversie en de laatste fout weergegeven.</p> <p>Het display van de besturing schakelt na 5 minuten zonder actie uit.</p>
--	--

De pomp loopt na een stroomstoring automatisch weer met het laatst ingestelde toerental of blijft stilstaan wanneer deze daarvoor werd gestopt.

Het in- en uitschakelen van de pomp moet plaatsvinden via de hiervoor bestemde stuurkabel (potentiaalvrije contacten), het analoge signaal of RS485. Dit kan worden uitgevoerd via een BADU-logicabesturing, BADU OmniTronic of een klein koppelrelais. Daardoor wordt de elektronica minder belast.

Overzicht van mogelijke waarschuwingen en foutmeldingen

Waarschuwingen

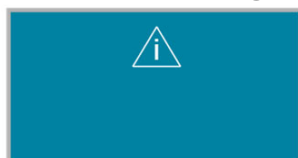

Waarschuwingen wijzen op systeemtoestanden met begrenzingsen. Ze worden elke tien seconden weergegeven, zolang er geen fout is. Bij hoge temperaturen wordt de actueel gemeten temperatuur van het betreffende onderdeel (PCB – printplaat, PFC of IPM – powermodule) weergegeven.

Na enige tijd wordt het apparaat omgeschakeld naar de derating-modus en wordt de capaciteit verlaagd. Dering wordt eveneens weergegeven als waarschuwing en overschrijft de eerder weergegeven overtemperatuurwaarschuwingen.

Waarschuwing	Grenswaarde
PCB temperatuur hoog	> 86 °C
PFC temperatuur hoog	> 86 °C
IPM temperatuur hoog	> 86 °C
Ingangsspanning hoog	> 255 V
Ingangsspanning laag	< 206 V
Derating start	Zie inverted parameter

Fouttype



Elke fout heeft een fout-reactietype, een aantal herhalingen van de reactie bij meer aanwezige fouten en een wachttijd tussen herhalingen van de fout (timeout).

Reactietype

Auto Try Again (ATA)	Voor algemene fouten: Het systeem zorgt elke x seconden voor een foutrest en probeert de laatste systeemtoestand weer te herstellen.
Wait on Action (WTA)	Voor kritieke fouten: Na een fout-rest door de gebruiker zorgt het systeem voor het weer herstellen van de systeemtoestand.
Memory Reset (MR)	Voor fouten bij de parametring en initialisatie: Het geheugen wordt gereset naar de fabrieksinstellingen en systeemhertstart van het applicatieboard wordt uitgevoerd.
Bootloader Watchdog (BW)	Voor updaten van niet compatibele software: Het uitvoeren van de software wordt voorkomen, een systeemupdate is vereist.

Door lang drukken (> 3 s) op de -toets  kan een fout worden bevestigd en gereset.

Fout

Nr.	Foutnaam	Reactie-type	Aantal herh.	Time-out
1	Under voltage	ATA	Oneindig	5 s
2	Over voltage	WTA	Oneindig	5 s
3	Wrong voltage at startup	ATA	1	10 s
4	Over temperature power modul	ATA	Oneindig	60 s
5	Over temperature motor	ATA	Oneindig	60 s
6	Over temperature PCB	ATA	Oneindig	60 s
8	Over temperature PFC	ATA	Oneindig	60 s
98	Communication	ATA	Oneindig	8 s
100	Drive Initialisation	ATA	Oneindig	15 s
101	No external release	ATA	Oneindig	30 s
102	Motor start failed	WTA	Oneindig	30 s
103	Over current phase	WTA	1	5 s
104	PFC undervoltage	WTA	Oneindig	5 s
105	Power module error	WTA	Oneindig	5 s
106	Power module passed on	WTA	Oneindig	5 s
107	Over current DCLink	WTA	Oneindig	5 s
200	HXIO Initialisation	MR	Oneindig	30s
201	HXIO Parametrization	MR	Oneindig	30s
202	HXIO RT Application	ATA	Oneindig	5s
210	HXIO Wrong HW-ID	BW	Oneindig	0 s
211	HXIO Wrong HW Version	BW	Oneindig	10 s
222	HXIO COM PM	ATA	Oneindig	20 s
223	HXIO COM PM Timeout	ATA	Oneindig	20 s
224	HXIO COM UI Timeout	ATA	Oneindig	10 s
225	HXIO COM SIO Timeout	ATA	Oneindig	10 s
230	HXIO EEPROM Error	ATA	Oneindig	5 s
231	HXIO EEPROM Error change block	ATA	1	5 s

Wanneer een defect is opgetreden, moet de installatie worden losgekoppeld van de voeding. Zie hoofdstuk 2.2 van de originele gebruiksaanwijzing "Normaal en zelfaanzuigende pompen met/zonder kunststof lantaarn (AK)".

Onderstaande opsomming heeft betrekking op de overige relevante documenten!

Deksel/filtermandje demonteren respectievelijk monteren

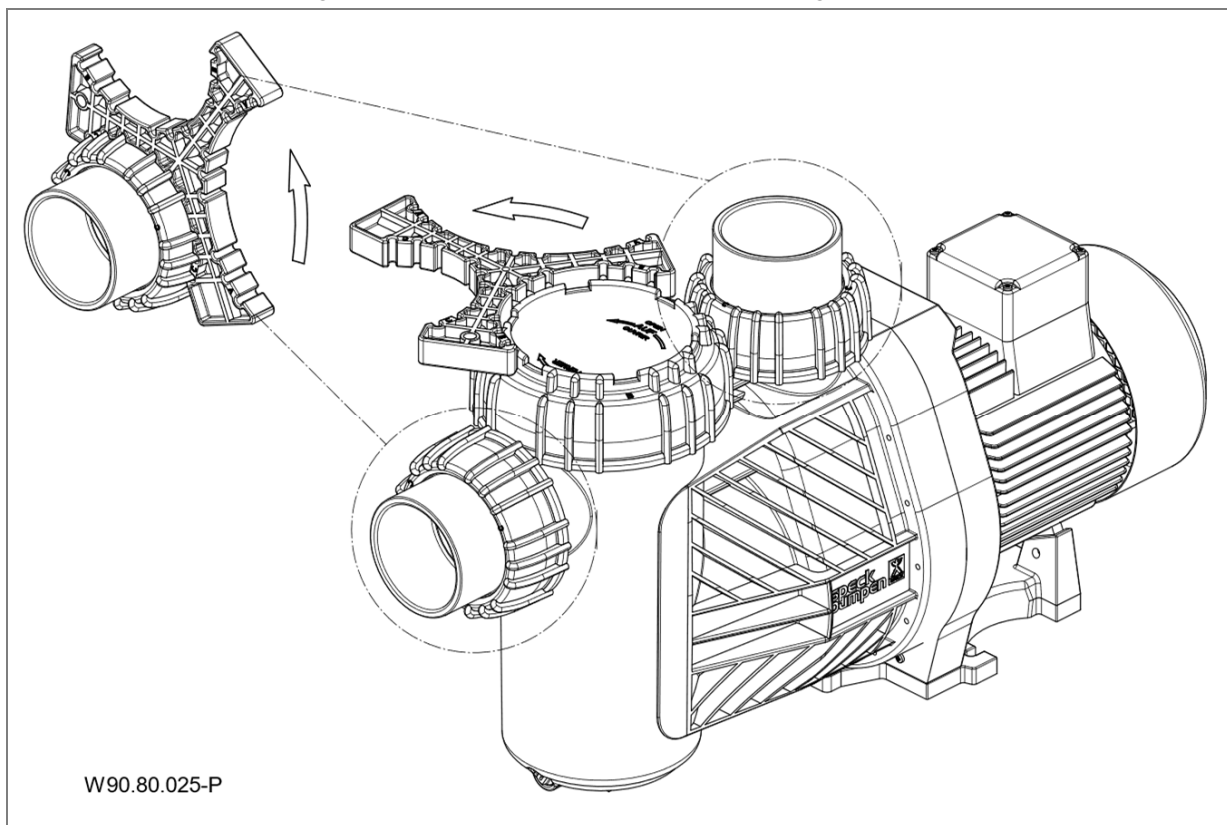

IT Documentazione pompe

Altri documenti applicabili

Le istruzioni di funzionamento originali "Pompe aspirazione normale e autodescanti, con e senza campana - esecuzione (AK)" fanno parte a questa documentazione pompa. Queste devono essere ben accessibili per il personale di servizio e per il personale di assistenza.

BADU[®] Eco Flex

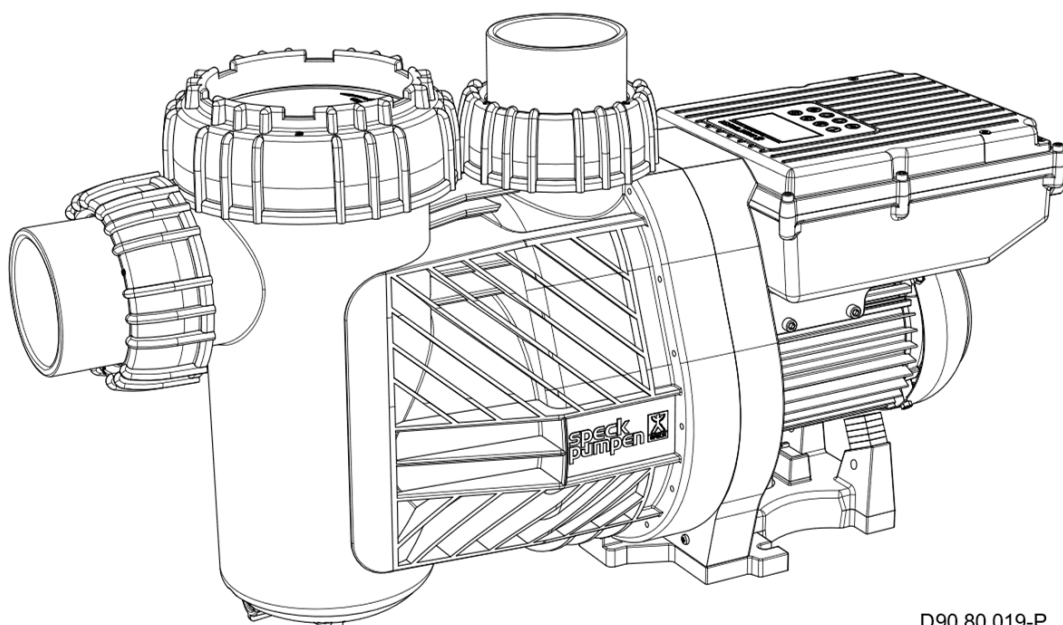

D90.80.019-P

Glossario	
TD	Dati tecnici
Sa	Raccordo aspirazione
Da	Raccordo mandata
d-Saug	Diametro aspirazione consigliato da 5 m
d-Druck	Diametro mandata consigliato da 5 m
max. L	Lunghezza massima della pompa
D	Densità
P ₁	Potenza assorbita
P ₂	Potenza resa
I	Corrente nominale
Lpa (1 m)	Livello di pressione acustica in 1 m di distanza. Misurato a norma DIN 45635
Lwa	Potenza acustica
m	Peso
WSK	Contatto di terra dell'avvolgimento oppure salvamotore
PTC	Conduttore a freddo
H _{max.}	Prevalenza massima
SP	Autoadescante
Hs; Hz	Altezza geodetica tra livello dell'acqua e pompa
Hs	Altezza massima aspirazione
Hz	Altezza massima a funzionamento sottobattente
IP	Tipo di protezione motore
W-KI	Classe isolamento
n	Numero di giri
P-GHI	2,5 bar massima pressione interna corpo/massima pressione sistema
T	Temperature acqua
●	Sì
○	No
T/°C	Spiegazione temperatura acqua 40 °C (60 °C): 40 °C = temperatura massima dell'acqua ai sensi del marchio. (60 °C) = la pompa può senz'altro funzionare anche con una temperatura acqua massima di 60 °C
1~/3~	Adatta per funzionamento continuo a 1~ 220 - 240 V ± 5% 3~ Y/Δ 380 - 420 V/220 - 240 V ± 5% 3~ Y/Δ 660 - 725 V/380 - 420 V ± 5% Adatta per tensione standard secondo normative DIN IEC 60038; DIN EN 60034

La pompa possiede un motore a magneti permanenti ed è protetta elettronicamente dal sovraccarico.

Collegamento di contatti di commutazione esterni

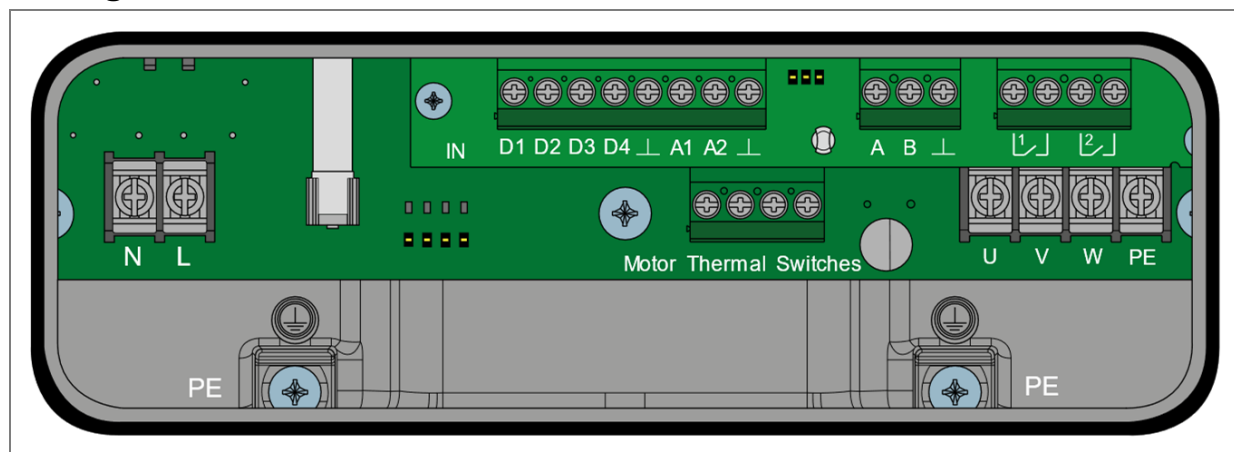

Tipo	Morsetto	Descrizione
Allacciamento alla rete	L	1~ 230V 50/60 Hz
	N	
	PE	Cavo di terra
Ingressi digitali (a potenziale zero)	D1	Marrone = n1
	D2	Verde = n2
	D3	Bianco = n3
	D4	Rosso = Stop
	⊥	Nero = GND
Ingressi analogici	A1	0-10 V
	A2	4-20 mA
	⊥	GND
RS485	A	RS485+
	B	RS485-
	⊥	GND
Relè	1	Riproduzione dello stato del motore max. 5A-250 V AC/5 A-30 V DC
	2	
Motor Thermal Switches	PTC1	Grigio – Grigio
	PTC2	Bianco – Bianco
Allacciamento del motore	U	Marrone
	V	Blu
	W	Nero
	PE	Verde/Giallo

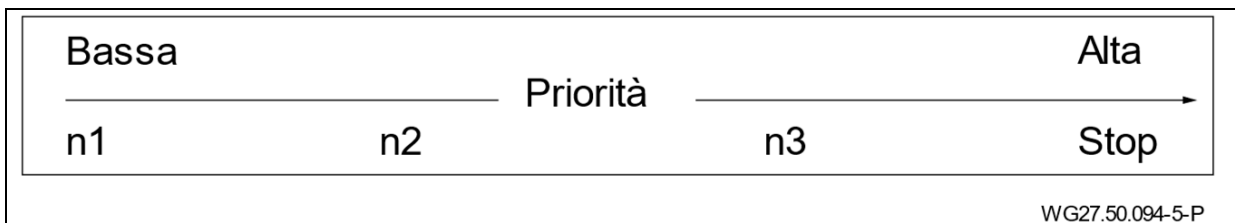

Riproduzione dello stato del motore tramite i relè 1 e 2

Il relè 1 chiude non appena il motore viene alimentato con tensione di rete e non vi sono errori. In caso di errore, il relè 1 si riapre. Il relè 2 chiude non appena il motore è in funzione.

Questa riproduzione dello stato del motore non permette una sicurezza al 100%, questo è garantito solo da un sensore di flusso o di pressione.

Comportamento di commutazione del segnale analogico

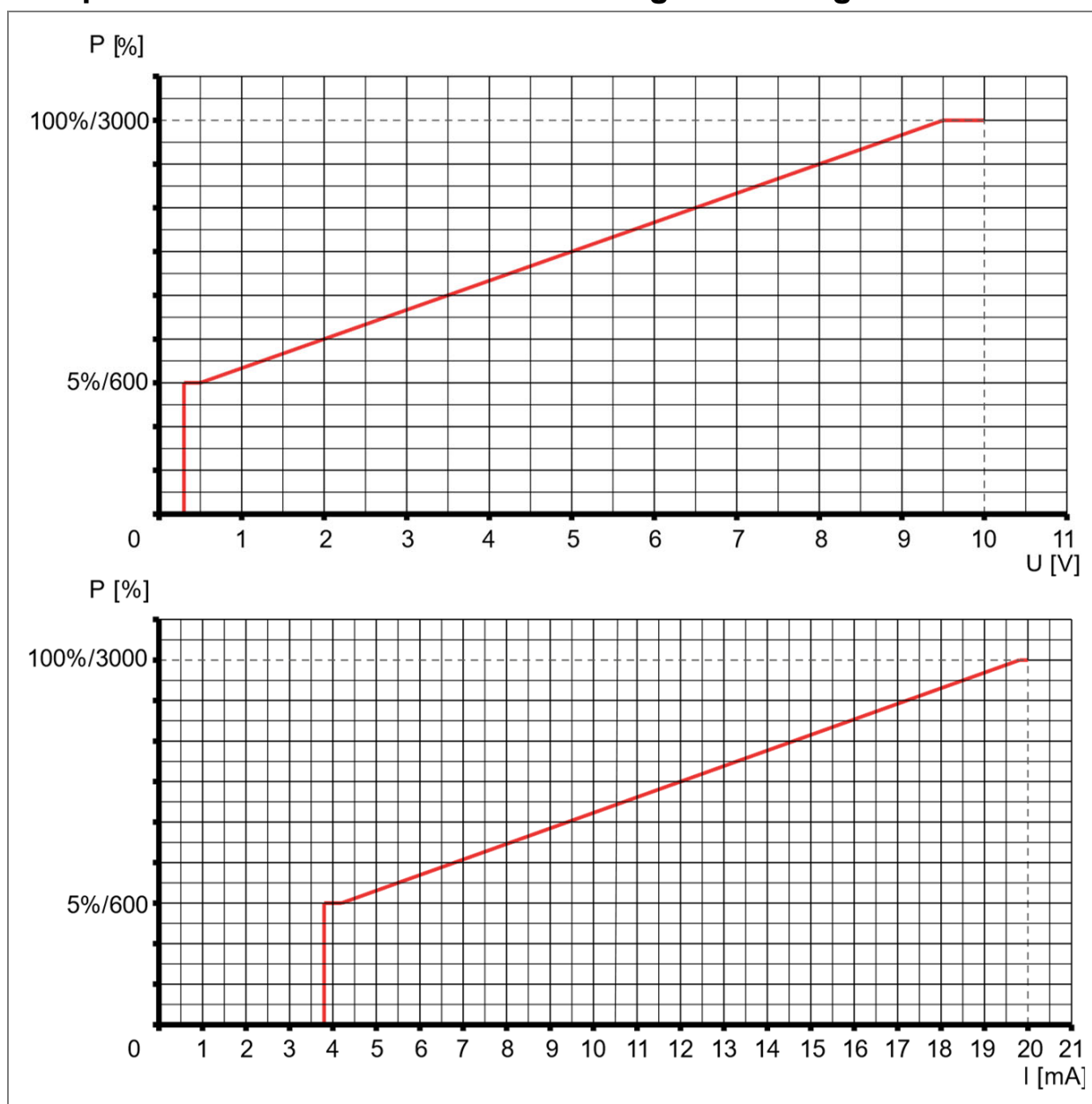

AVVISO

Attivazione del numero di giri del motore mediante pulsanti manuali o contatti di commutazione esterni. In tal modo si attivano i contatti di commutazione ed il numero di giri associato.

Se la pompa parte da ferma, si avvia in modalità di adescamento e di seguito alla velocità fissa selezionata, ad eccezione del controllo analogico 0-10 V, 4-20 mA e RS485.

A pompa in funzione, i numeri di giri fissi vengono raggiunti direttamente senza tempo di aspirazione.

Se il comando esterno non è necessario, le estremità del cavo devono essere isolati.

AVVISO

Per l'interazione perfetta con le unità periferiche, quali ad es. scambiatore di calore elettronico o impianti di dosaggio, raccomandiamo l'installazione di un flussostato con rispettiva unità di valutazione che permette anche l'emissione di una segnalazione di guasto.

AVVISO

Per evitare malfunzionamenti, devono essere assolutamente osservati i seguenti punti:

- Linea di controllo deve essere postata a regola d'arte. Deve essere evitato un montaggio parallelo alla linea di rete o altre reti di utenza.
 - Prolunghe della linea di controllo possono provocare tensioni pericolose al digitale di ingresso. Evitare con schermature.
 - Non collegare cavi di rete di altre risorse alla stessa linea di alimentazione.
-

Selezione del modo operativo

Con questo motore è possibile distinguere tra due modi operativi (modalità). Il motore può essere regolato o attraverso il numero di giri o attraverso la potenza.

Nella modalità „velocità costante“, la velocità desiderata è impostata sul motore e questa velocità viene mantenuta costante tramite la curva caratteristica.

Nella modalità “potenza costante” la potenza desiderata viene impostata in % sul motore e mantenuta costante su tutta la curva caratteristica. In questo caso il motore regola automaticamente il numero di giri in base alla potenza impostata.

Modalità	Numero di giri costante *	Potenza costante
Impostazione predefinita:		
Numero di giri/Potenza:	1 = 2000 min ⁻¹ 2 = 2500 min ⁻¹ 3 = 3000 min ⁻¹	1 = 60 % 2 = 80 % 3 = 100 %
Numero di giri aspirazione/ Potenza aspirazione:	= 3000 min ⁻¹	= 100 %
Tempo di aspirazione:	= 5 minuti	= 5 minuti
Numero di giri/Potenza regolabili:	600 – 3000 min ⁻¹ (<i>ad incrementi di 10min⁻¹</i>)	5 – 100 % (<i>ad incrementi di 1 %</i>)
Tempo di aspirazione regolabile:	oFF, 1 – 10 Min. (<i>ad incrementi di 1 min</i>)	oFF, 1 – 10 Min. (<i>ad incrementi di 1 min</i>)
Lingua:	english	english
Attivazione esterna:	nessuno	nessuno

* La funzione „numero di giri costante“ impostazione di fabbrica.

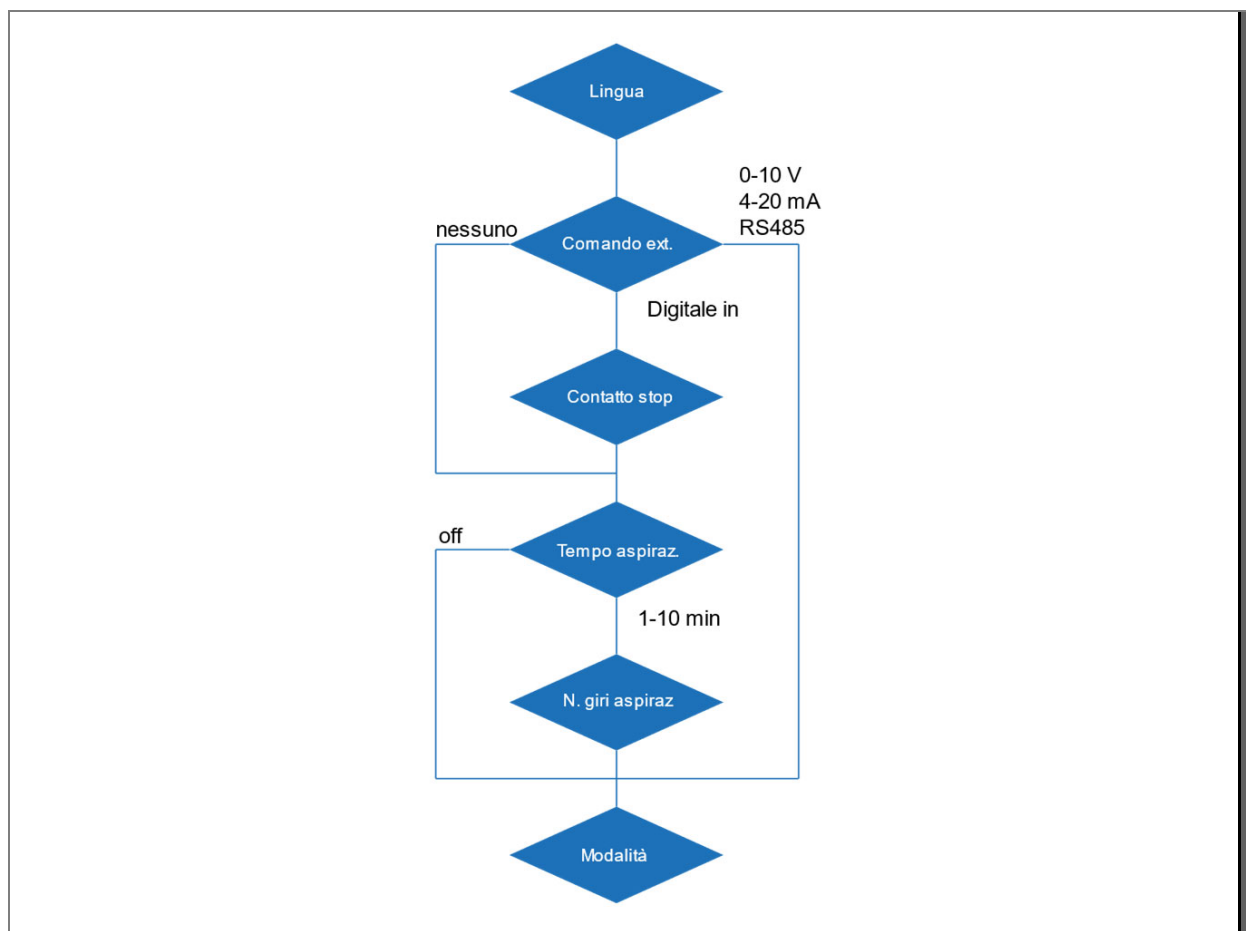

Struttura del menù di configurazione

A seconda della selezione o dell'impostazione, le voci di menù vengono visualizzate o nascoste secondo il diagramma seguente.

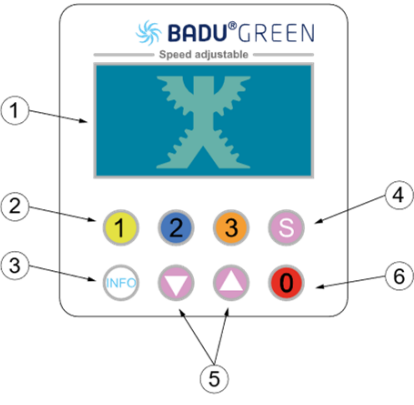

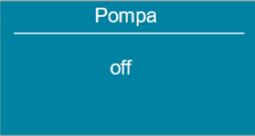

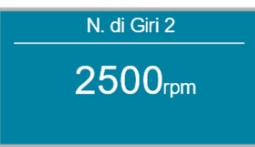
	<p>Pannello di controllo:</p> <p>(1) Display a LCD: visualizza il numero di giri/la resa attuale del motore.</p> <p>(2) 1 2 3 : selezione dei numeri di giri/ resettare preimpostati</p> <p>(3) INFO : visualizzazione del consumo attuale e selezione nel menu di setup</p> <p>(4) S : impostazione dei parametri</p> <p>(5) ▼ ▲ : modifica del numero di giri/la resa/parametri</p> <p>(6) 0 : arresto del motore</p>
---	--

	<p>Comando:</p> <p>Premere il tasto 1 2 o 3 per selezionare il numero di giri/la portata preimpostato. Avviando la pompa da ferma, essa inizia a funzionare in modalità di aspirazione (se attivata) e poi con il numero di giri/il livello di portata fisso selezionato. A pompa in funzione, i numeri di giri/il livello di portata vengono raggiunti direttamente senza tempo di aspirazione.</p> <p>Premendo il tasto 0, il motore si arresta. Se nei parametri è impostato un controllo analogico o RS485, il motore può essere riavviato con il tasto 1.</p>
---	---

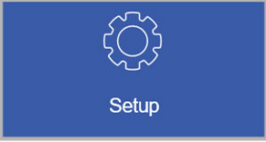
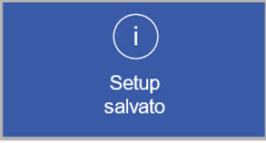
	<p>Impostazione dei numeri di giri/di portata:</p> <p>Premere il tasto del numero di giri fisso/il livello di portata da modificare (1 2 3) e poi modificare il numero di giri/portata premendo i tasti ▼ ▲. Il numero di giri/ portata impostato viene memorizzato direttamente e si riattiva rifelezionando il numero di giri fisso/il livello di portata.</p>
	<p>Avviso: Durante la fase di aspirazione il numero di giri/portata non può essere modificato.</p>

	<p>Impostazione dei parametri: Premendo il tasto S per 3 secondi si passa al menu di setup. Qui è possibile scorrere nel menù con il pulsante INFO e modificare i parametri e le impostazioni con i pulsanti ▼▲. Premendo il tasto S all'interno del menu, tutti i valori modificati vengono memorizzati e si esce dal menu di setup. Premendo il tasto 0, dal menu di setup si esce senza memorizzare i valori modificati.</p>
	



	<p>Lingua: La lingua può essere impostata alla voce di menù „Lingua“. Con i tasti ▼▲ è possibile cambiare la lingua. Possono essere selezionate le lingue seguenti:</p> <ul style="list-style-type: none"> • Tedesco • Inglese • Francese • Italiano • Olandese • Spagnolo
---	--

	<p>Ingressi digitali e analogici: Il tipo di controllo esterno può essere specificato alla voce del menù „Comando ext.“.</p> <p>nessuno = disattivata Digitale in = ingressi digitali (potenziale zero) attivati 0-10 V = Ingresso analogico 0-10 V 4-20 mA = Ingresso analogico 4-20 mA RS485 = Protocollo su richiesta</p>
--	---

	<p>Comportamento di commutazione contatto stop: Nella voce contatto stop si può modificare il comportamento di commutazione dell'ingresso digitale stop.</p> <p>Chiuso significa, il motore si arresta a contatto chiuso. Aprire significa, il motore si arresta a contatto aperto. Senza segnale significa, non è necessario il contatto esterno per l'arresto. Aprire il contatto GND arresta il motore.</p>
---	---

	<p>Parametri di aspirazione: Nelle voci di menù „Tempo di adescamento“ e "Velocità/potenza di adescamento" è possibile definire un tempo e una velocità/potenza, con cui la pompa aspira l'acqua dopo un arresto e sfiata la tubazione.</p>
---	--

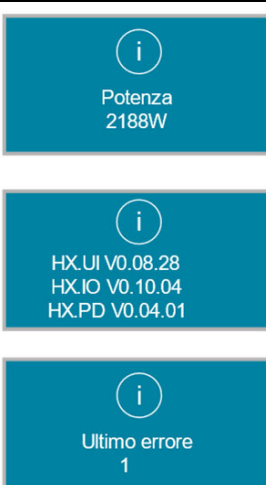
	<p>Reset: Premendo il tasto  per almeno 10 secondi, il motore viene resettato sulle impostazioni predefinite. Il motore si arresta ed il display visualizza “reset”.</p>
---	--

	<p>Premendo il pulsante , sul display vengono visualizzati la potenza assorbita attuale, la versione del software e l'ultimo errore.</p> <p>Il display del controllore si spegne dopo 5 minuti senza azioni.</p>
--	---

In seguito ad una caduta di tensione, la pompa si riavvia automaticamente con l'ultimo numero di giri impostato o resta ferma se prima era stata arrestata.

Le operazioni di accensione e spegnimento della pompa devono essere realizzate attraverso l'apposito cavo di controllo (contatti a potenziale zero), il segnale analogico oppure RS485. Ciò può avvenire attraverso un controllo BADU-Logic, BADU OmniTronic o un relè di accoppiamento. In questo modo vengono ridotte le sollecitazioni a cui è sottoposta l'elettronica.

Panoramica dei possibili avvisi e messaggi di errore

Avvisi

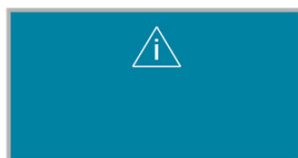

Gli avvisi indicano gli stati limite del sistema. Vengono visualizzati ogni dieci secondi finché non vi sono errori. A temperature elevate viene visualizzata la temperatura misurata al momento del componente interessato (scheda PCB, PFC o modulo di alimentazione IPM). Dopo un

certo tempo l'apparecchio passa alla modalità di derating e le prestazioni si riducono. Anche il derating viene visualizzato come avviso e sovrascrive gli avvisi di sovratemperatura visualizzati in precedenza.

Avviso	Valore limite
Temperatura PCB alta	>86 °C
Temperatura PFC alta	>86 °C
Temperatura IPM alta	>86 °C
Tensione di ingresso alta	>255 V
Tensione di ingresso bassa	<206 V
Avvii di derating	Vedi i parametri dell'inverter

Tipo di errore



Ogni errore ha un tipo di reazione all'errore, un numero di ripetizioni della reazione in caso di ulteriori errori e un tempo di attesa tra le ripetizioni dell'errore (timeout).

Tipo di reazione

Auto Try Again (ATA)	Per errori generali: Il sistema esegue automaticamente un reset degli errori ogni x secondi e tenta di ripristinare l'ultimo stato del sistema.
Wait on Action (WTA)	Per errori critici: Dopo un errore di reset da parte dell'utente, il sistema avvia il ripristino dell'ultimo stato del sistema.
Memory Reset (MR)	Per errori nella parametrizzazione e inizializzazione: La memoria viene resettata alle impostazioni di fabbrica e viene effettuato un riavvio di sistema della scheda dell'applicazione.
Bootloader Watchdog (BW)	Per l'aggiornamento di software incompatibile: Viene impedita l'esecuzione del software ed è necessario un aggiornamento del sistema.

Un errore può essere confermato e resettato premendo a lungo (>3s) il pulsante .

Errore

N°	Nome dell'errore	Tipo di reazione	Numero ripetiz.	Time-out
1	Under voltage	ATA	Infinito	5s
2	Over voltage	WTA	Infinito	5s
3	Wrong voltage at startup	ATA	1	10s
4	Over temperature power modul	ATA	Infinito	60s
5	Over temperature motor	ATA	Infinito	60s
6	Over temperature PCB	ATA	Infinito	60s
8	Over temperature PFC	ATA	Infinito	60s
98	Communication	ATA	Infinito	8s
100	Drive Initialisation	ATA	Infinito	15s
101	No external release	ATA	Infinito	30s
102	Motor start failed	WTA	Infinito	30s
103	Over current phase	WTA	1	5s
104	PFC undervoltage	WTA	Infinito	5s
105	Power module error	WTA	Infinito	5s
106	Power module passed on	WTA	Infinito	5s
107	Over current DCLink	WTA	Infinito	5s
200	HXIO Initialisation	MR	Infinito	30s
201	HXIO Parametrization	MR	Infinito	30s
202	HXIO RT Application	ATA	Infinito	5s
210	HXIO Wrong HW-ID	BW	Infinito	0s
211	HXIO Wrong HW Version	BW	Infinito	10s
222	HXIO COM PM	ATA	Infinito	20s
223	HXIO COM PM Timeout	ATA	Infinito	20s
224	HXIO COM UI Timeout	ATA	Infinito	10s
225	HXIO COM SIO Timeout	ATA	Infinito	10s
230	HXIO EEPROM Error	ATA	Infinito	5s
231	HXIO EEPROM Error change block	ATA	1	5s

Se si verifica un difetto, l'impianto deve essere scollegato dalla tensione di alimentazione. Vedere il capitolo 2.2 delle istruzioni di funzionamento originali "Pompe aspirazione normale e autoadescanti, con e senza campana – esecuzione (AK)".

I seguenti elenchi riguardano i documenti di riferimento!

Smontaggio e montaggio del coperchio/cestello

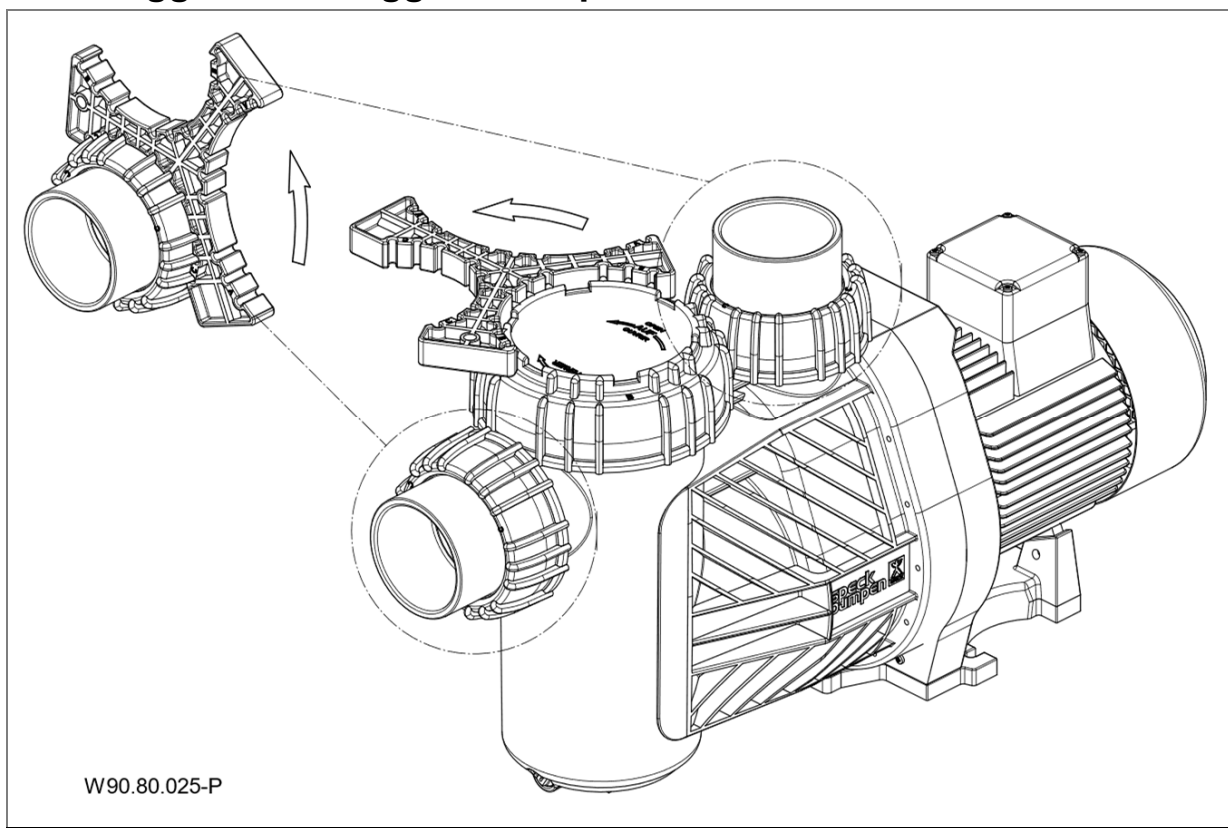

ES Ficha técnica de la bomba

Documentos incluidos

Este documento forma parte de las instrucciones originales para bombas de "aspiración normal y bombas auto-aspirantes con/sin la versión (AK)". Se recomienda mantenerlo de fácil acceso para el personal de operación y mantenimiento.

BADU[®] Eco Flex

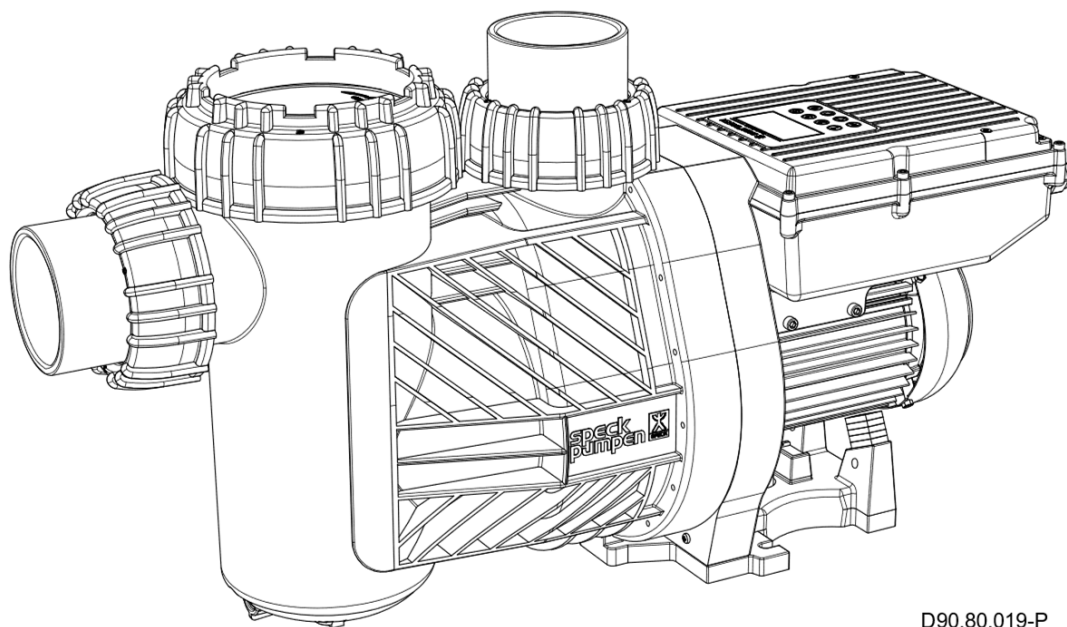

D90.80.019-P

Glosario	
TD	Datos técnicos
Sa	Conexión por aspiración
Da	Conexión por presión
d-Saug	Diámetro recomendado de la conexión por aspiración a 5 m
d-Druck	Diámetro recomendado de la conexión por presión a 5 m
max. L	Maximo largo de la bomba
D	Densidad
P ₁	Potencia absorbida
P ₂	Potencia disipada
I	Corriente nominal
Lpa (1 m)	Nivel de presión acústica a un metro de distancia. Mido según norma DIN 45635
Lwa	Potencia acústica
m	Peso
WSK	Protector térmico integrado en la bobina del motor
PTC	Termistor PTC
H _{max.}	Altura máxima de presión
SP	Auto-aspirante
Hs; Hz	Altura geodésica sobre el nivel del agua y la bomba
Hs	Aspiración total
Hz	Elevación total en la aspiración
IP	Protección del motor
W-KI	Aislamiento tipo
n	Velocidad de giro
P-GHI	2,5 bar presión interna máxima de carcasa/presión máxima del sistema
T	Temperatura del agua
●	Si
○	No
T/°C	Explicación de la temperatura del agua 40 °C (60 °C): 40 °C = vale para temperaturas máximas conforme a las normas GS. (60 °C) = La bomba puede funcionar para una temperatura del agua de 60 °C
1~/3~	Apropiado para un servicio continuo a 1~ 220 - 240 V ± 5% 3~ Y/Δ 380 - 420 V/220 - 240 V ± 5% 3~ Y/Δ 660 - 725 V/380 - 420 V ± 5% Apropiado para una tensión según la normas DIN IEC 60038; DIN EN 60034

La bomba tiene un motor de imán permanente y está protegida electrónicamente contra sobrecarga.

Conexión de contactos de conmutación externos

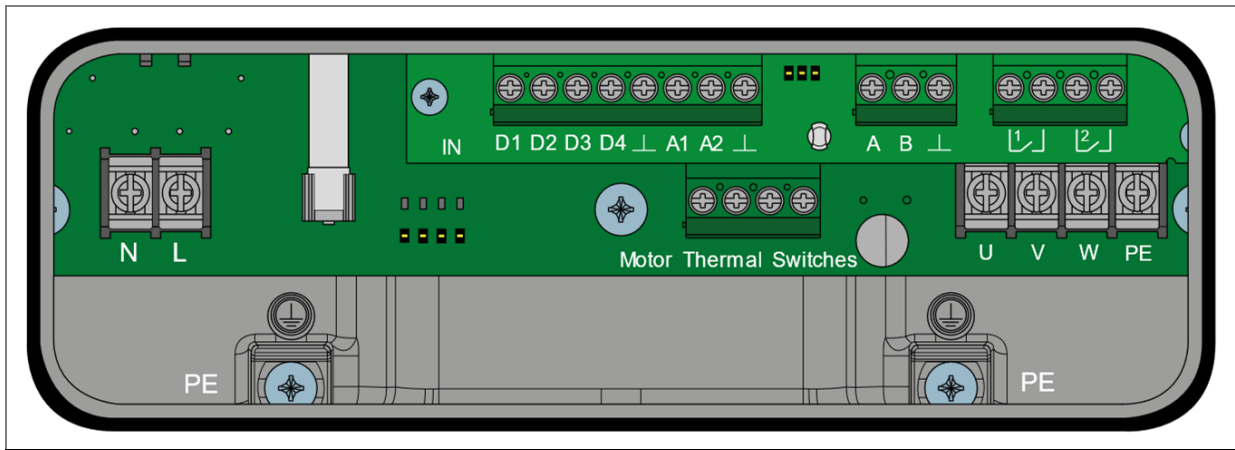

Tipo	Borne	Descripción
Conexión de red	L	1~ 230V 50/60 Hz
	N	
	PE	Conductor puesta a tierra
Entradas digitales (libres de potencial)	D1	Marrón = n1
	D2	Verde= n2
	D3	Blanco = n3
	D4	Rojo = Parada
	⊥	Negro = GND
Entradas analógicas	A1	0-10 V
	A2	4-20 mA
	⊥	GND
RS485	A	RS485+
	B	RS485-
	⊥	GND
Relé	1	Indicador de estado del motor máx. 5A-250 V AC/5 A-30 V DC
	2	
Motor Thermal Switches	PTC1	Gris -- Gris
	PTC2	Blanco - Blanco
Conexión de motor	U	Marrón
	V	Azul
	W	Negro
	PE	Verde/amarillo

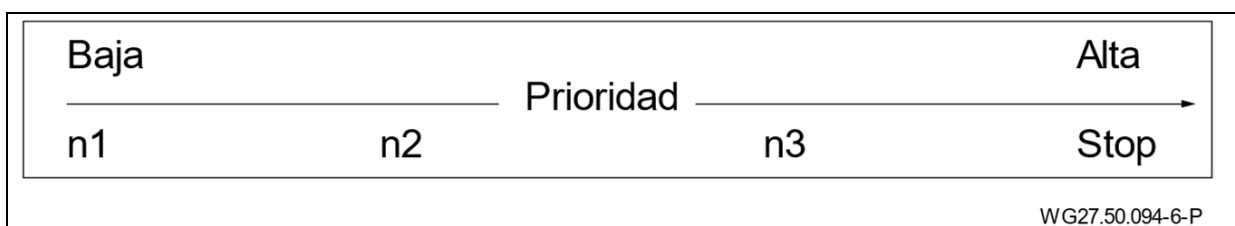

WG27.50.094-6-P

Reproducción del estado de motor mediante relé 1 y 2

El relé 1 cierra al instante que le llega tensión de alimentación al motor y no hay ningún error. En caso de error el relé 1 vuelve abrir. Al momento que el motor funciona cierra el relé 2.

Esta reproducción del estado del motor no ofrece un 100- % de seguridad, esto sólo se garantiza con un sensor de flujo o de presión.

Respuesta de conmutación señal analógica

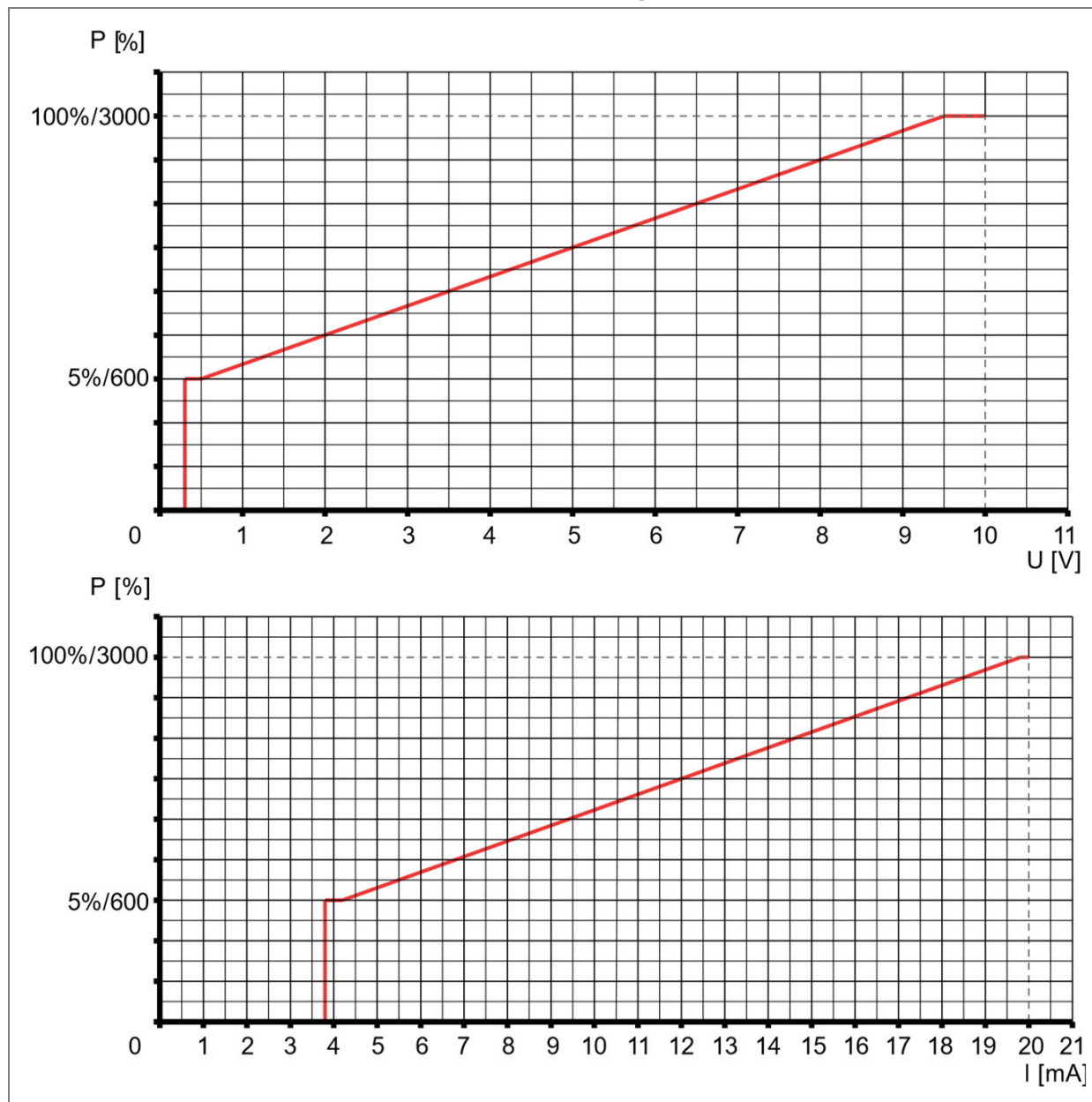

AVISO

Poner en marcha la velocidad del motor mediante botón pulsador o contactos de conmutación externos. De esta manera se activan los contactos de conmutación y la velocidad de giro asignada.

Si la bomba arranca desde el estado parado, funcionará en modo de succión y a continuación a la velocidad fija seleccionada, exceptuando el control analógico 0-10 V, 4-20 mA y RS485.

Durante el funcionamiento las velocidades fijas se aplican directamente, sin tiempo de aspiración.

Si el mando externo no se necesita, deben aislarse los cabos de cable.

AVISO

Para la interacción sin problemas con equipos periféricos, p. ej. intercambiadores de calor eléctricos o instalaciones dosificadoras, se recomienda el montaje de un interruptor de caudal con la correspondiente unidad de evaluación. De este modo, también es posible emitir un mensaje de avería.

AVISO

Para evitar el mal funcionamiento del motor, deben tenerse en cuenta los siguientes puntos.:

- La línea de control debe estar conectada correctamente. Debe evitarse un montaje paralelo a su propio cable de alimentación o a otros puntos de consumo.
 - Si se amplían las líneas de control, pueden surgir tensiones peligrosas en la entrada digital. Esto debe evitarse, por ejemplo con protecciones adicionales como el cifrado.
 - No utilice el cable de alimentación de diferentes recursos en la misma línea de suministro.
-

Selección del modo operativo

En este motor puede distinguirse entre dos modos operativos (modo). El motor puede regularse mediante la velocidad o bien mediante la potencia. En el modo operativo „velocidad constante“ se ajusta la velocidad deseada en el motor y esta velocidad se mantiene constante a través de la curva característica.

En el modo operativo „potencia constante“ se ajusta la potencia deseada en % en el motor y se mantiene constante a lo largo de toda la curva característica. Aquí, en función de la potencia ajustada el motor regula automáticamente la velocidad.

Modo	Velocidad constante *	Potencia constante
Ajuste previo:		
Velocidad/Potencia:	1 = 2000 min ⁻¹ 2 = 2500 min ⁻¹ 3 = 3000 min ⁻¹	1 = 60 % 2 = 80 % 3 = 100 %
Velocidad de aspiración/ Potencia de aspiración:	= 3000 min ⁻¹	= 100 %
Tiempo de aspiración:	= 5 minutos	= 5 minutos
Velocidades/Potencia ajustables:	600 – 3000 min ⁻¹ (en pasos de 10 min ⁻¹)	5 – 100 % (en pasos de 1 %)
Tiempo de aspiración ajustable:	off, 1 – 10 min. (en pasos de 1 min)	off, 1 – 10 min. (en pasos de 1 min)
Idioma	english	english
Mando externo:	ninguno	ninguno

* La función "Velocidad constante" corresponde al ajuste de fábrica.

Estructura de menú setup

Según la selección o bien ajuste, se muestran o se ocultan los puntos de menú conforme al diagrama siguiente.

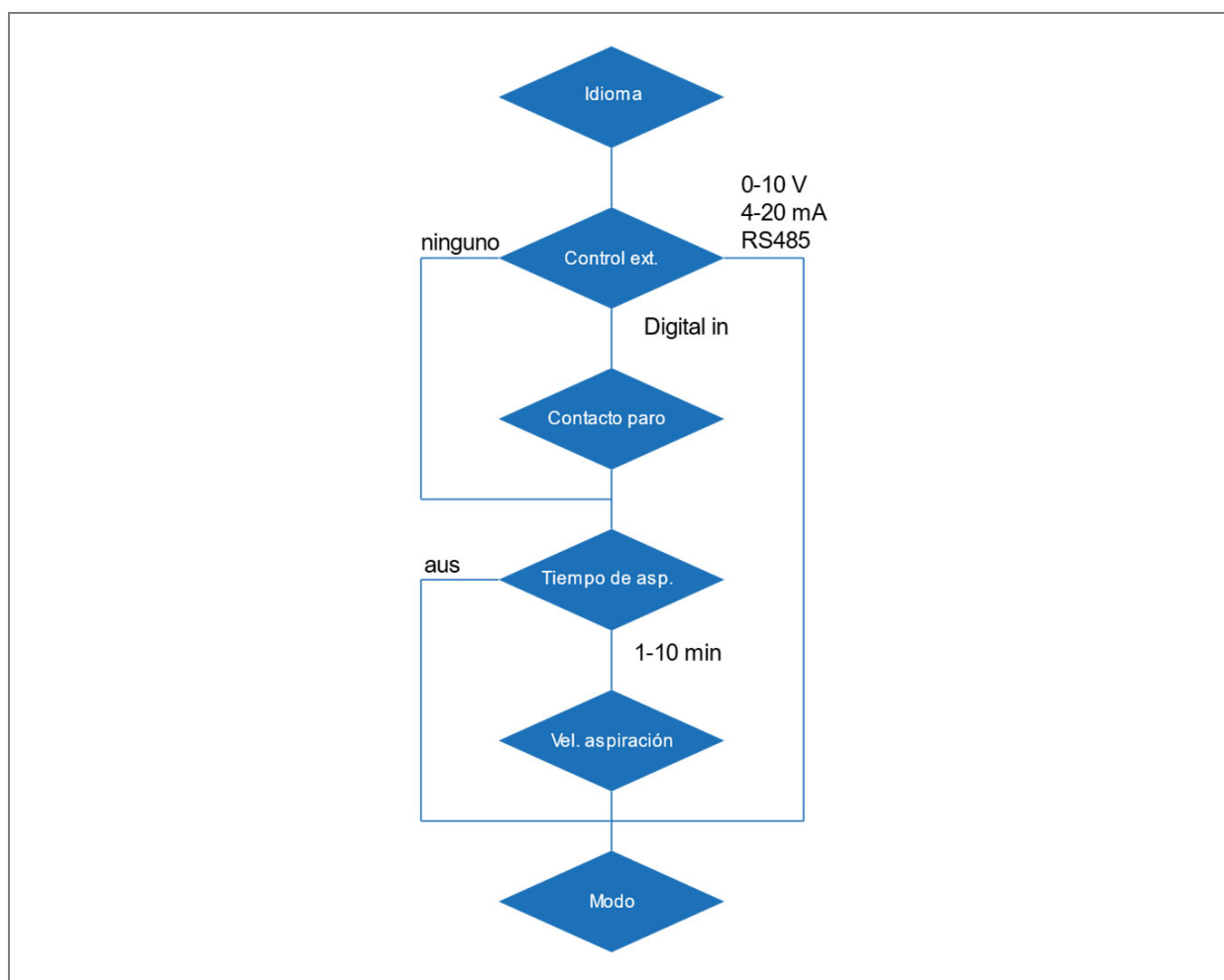

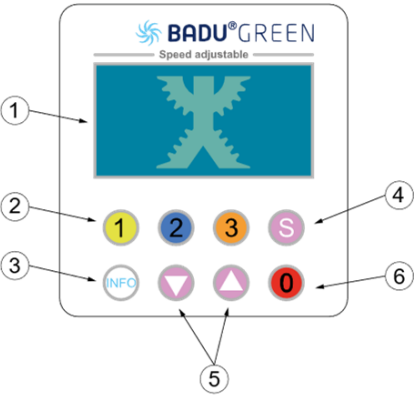

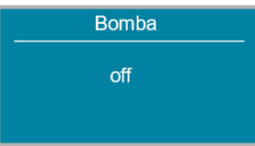
	<p>Interfaz de usuario:</p> <p>(1) Display de LCD: indica la actual velocidad de giro/potencia en porcentaje del motor.</p> <p>(2) 1 2 3: selección de las velocidades de giro/la potencia preconfiguradas</p> <p>(3) INFO: para indicación del consumo actual y la selección de las opciones de menú en la configuración</p> <p>(4) S: para ajustar los parámetros</p> <p>(5) ▼ ▲: para modificar las velocidad de giro/la potencia/los parámetros</p> <p>(6) 0: para detener el motor</p>
---	--

	<p>Manejo:</p> <p>Pulsar la tecla 1 2 o 3 para seleccionar la velocidad de giro fija/la potencia preconfigurada. Si arranca la bomba cuando está parada, se pone en marcha en el modo de aspiración (si está activado) y a continuación con la velocidad de giro fija/la potencia seleccionada. Durante el funcionamiento las velocidades de giro/la potencia se aplican directamente, sin tiempo de aspiración. Apretando la tecla 0 se detiene el motor. Si viene configurado en los parámetros un control analógico o RS485, se puede reanunciar el motor con la tecla 1.</p>
---	--

	<p>Ajuste de las velocidades de giro/potencia:</p> <p>Pulsar la tecla de la velocidad de giro fija/la potencia que debe modificarse (1 2 3) y después modificar la velocidad de giro/ potencia con las teclas ▼ ▲. La velocidad de giro/potencia ajustada se almacena inmediatamente y en la siguiente selección se traslada a la velocidad de giro fija/ la potencia.</p>
---	---

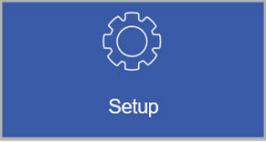
	<p>Nota: La velocidad de giro/la potencia no se puede cambiar durante la fase de aspiración.</p>
---	---



	<p>Ajuste de los parámetros: El menú Setup se selecciona manteniendo pulsada la tecla S durante 3 segundos. En el puede desplazarse por el menú con la tecla INFO y cambiar los parámetros y configuración con las teclas ▼ ▲. Si en el menú se pulsa la tecla S, se guardan entonces todos los valores cambiados y se sale del menú Setup. Pulsando la tecla 0 se sale del menú Setup sin guardar los valores cambiados.</p>
	

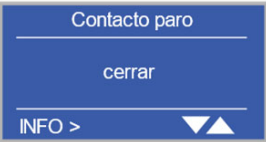

	<p>Idioma: En el punto de menú „Idioma“ se puede ajustar el idioma. Usando las teclas ▼ ▲ se puede cambiar entre los idiomas. Se pueden seleccionar los idiomas siguientes:</p> <ul style="list-style-type: none"> • alemán • inglés • francés • Italiano • neerlandés • español
---	---

	<p>Entradas digitales y analógicas: En el punto de menú „Control ext.“ se puede prefijar el tipo de control externo. ninguno = desactivado Digital en = entradas digitales (sin potencial) activadas 0-10 V = Entrada analógica 0-10 V 4-20 mA = Entrada analógica 4-20 mA RS485 = Protocolo a petición</p>
--	---

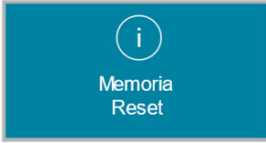
	<p>Reacción de conexión contacto paro: Bajo la opción contacto paro se puede modificar la reacción de conexión de la entrada digital stop. Cerrar significa que el accionamiento de traslación se para con el contacto de STOP cerrado. Abrir significa que el accionamiento de traslación se para con el contacto de STOP abierto. Sin señal significa que no es necesario una conexión de contacto externo para parar el accionamiento. Si se abre el contacto GND se para el accionamiento.</p>
---	--

	<p>Parámetro de succión: En los puntos de menú „tiempo de succión“ y „velocidad/potencia de succión“ se puede definir un tiempo y velocidad/potencia con la que succionará el agua después de una parada y el purgado de la tubería.</p>
---	---

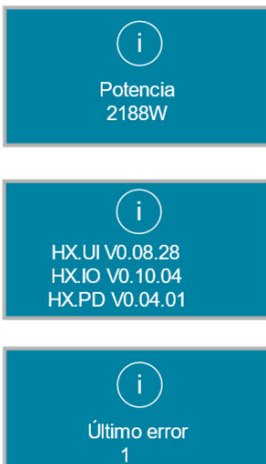
	<p>Restaurar / Reset: Si la tecla  se pulsa por lo menos durante 10 segundos, el accionamiento se restaura al ajuste de fábrica. El motor se detiene y en el display aparece “reset”.</p>
---	---

	<p>Pulsando la tecla  se muestra en pantalla la demanda de potencia actual, la versión del software y el último error ocasionado.</p> <p>El display del mando se apaga después de 5 minutos sin acción.</p>
--	--

La bomba arranca automáticamente después de un corte de corriente de nuevo con la velocidad de giro últimamente ajustada, o permanece parada si antes se detuvo.

El encendido y el apagado de la bomba deben realizarse a través del cable de control previsto para ello (contactos sin potencial), la señal analógica o bien RS485. Esto puede hacerse a través de un control BADU-lógico, BADU OmniTronic o a través de un relé de acoplamiento pequeño. De este modo se carga menos el sistema electrónico.

Resumen de posibles advertencias y mensajes de error

Advertencias

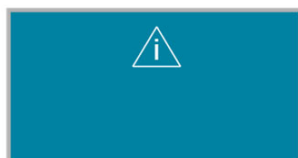

Las advertencias indican estados del sistema límites. Mientras no haya ningún error se visualizan cada diez segundos. Con altas temperaturas se visualiza la temperatura medida actualmente del componente afectado (placa de circuito - PCB, módulo de potencia PFC o bien IPM).

Transcurrido un tiempo el aparato conmuta al modo derating y la potencia se reduce. La reducción se visualiza también como advertencia y sobrescribe las advertencias de sobret temperatura mostradas anteriormente.

Advertencia	Valor límite
PCB temperatura alta	>86 °C
PFC temperatura alta	>86 °C
IPM temperatura alta	>86 °C
Tensión de entrada alta	>255 V
Tensión de entrada baja	<206 V
Derating starts	Véase parámetros del inversor

Tipo de error



Cada error conlleva un tipo de reacción de error, un número de repeticiones de la reacción en caso que persistan errores y un tiempo de espera entre las repeticiones del error (timeout).

Tipo de reacción

Auto Try Again (ATA)	Para errores comunes: El sistema se encarga de realizar un reset de error automáticamente cada x segundos e intenta restaurar el último estado del sistema.
Wait on Action (WTA)	Para errores críticos: Después de que el usuario realice un reset de error, el sistema restablece el estado de sistema último.
Memory Reset (MR)	Para los errores durante la parametrización e inicialización: La memoria se restaura a los ajustes de fábrica y se realiza un reinicio del sistema de la placa de aplicación.
Bootloader Watchdog (BW)	Para la actualización de software no compatible: Se impide la ejecución del software, se precisa una actualización del sistema.

Con una pulsación prolongada (>3s) de la tecla , se puede confirmar y resetear un error.

Error

Nº.	Nombre del error	Tipo de reacción	Número de repet.	Time-out
1	Under voltage	ATA	Infinito	5s
2	Over voltage	WTA	Infinito	5s
3	Wrong voltage at startup	ATA	1	10s
4	Over temperature power modul	ATA	Infinito	60s
5	Over temperature motor	ATA	Infinito	60s
6	Over temperature PCB	ATA	Infinito	60s
8	Over temperature PFC	ATA	Infinito	60s
98	Communication	ATA	Infinito	8s
100	Drive Initialisation	ATA	Infinito	15s
101	No external release	ATA	Infinito	30s
102	Motor start failed	WTA	Infinito	30s
103	Over current phase	WTA	1	5s
104	PFC undervoltage	WTA	Infinito	5s
105	Power module error	WTA	Infinito	5s
106	Power module passed on	WTA	Infinito	5s
107	Over current DCLink	WTA	Infinito	5s
200	HXIO Initialisation	MR	Infinito	30s
201	HXIO Parametrization	MR	Infinito	30s
202	HXIO RT Application	ATA	Infinito	5s
210	HXIO Wrong HW-ID	BW	Infinito	0s
211	HXIO Wrong HW Version	BW	Infinito	10s
222	HXIO COM PM	ATA	Infinito	20s
223	HXIO COM PM Timeout	ATA	Infinito	20s
224	HXIO COM UI Timeout	ATA	Infinito	10s
225	HXIO COM SIO Timeout	ATA	Infinito	10s
230	HXIO EEPROM Error	ATA	Infinito	5s
231	HXIO EEPROM Error change block	ATA	1	5s

Si se produce un defecto, la instalación se tiene que desconectar de la alimentación eléctrica. Ver capítulo 2.2 de las instrucciones originales para bombas de "Aspiración normal y bombas auto-aspirantes con/sin la versión (AK)".

Las siguientes enumeraciones se refieren a los documentos convalidados!

Tapar/montaje o desmontaje de los prefiltros de aspiración

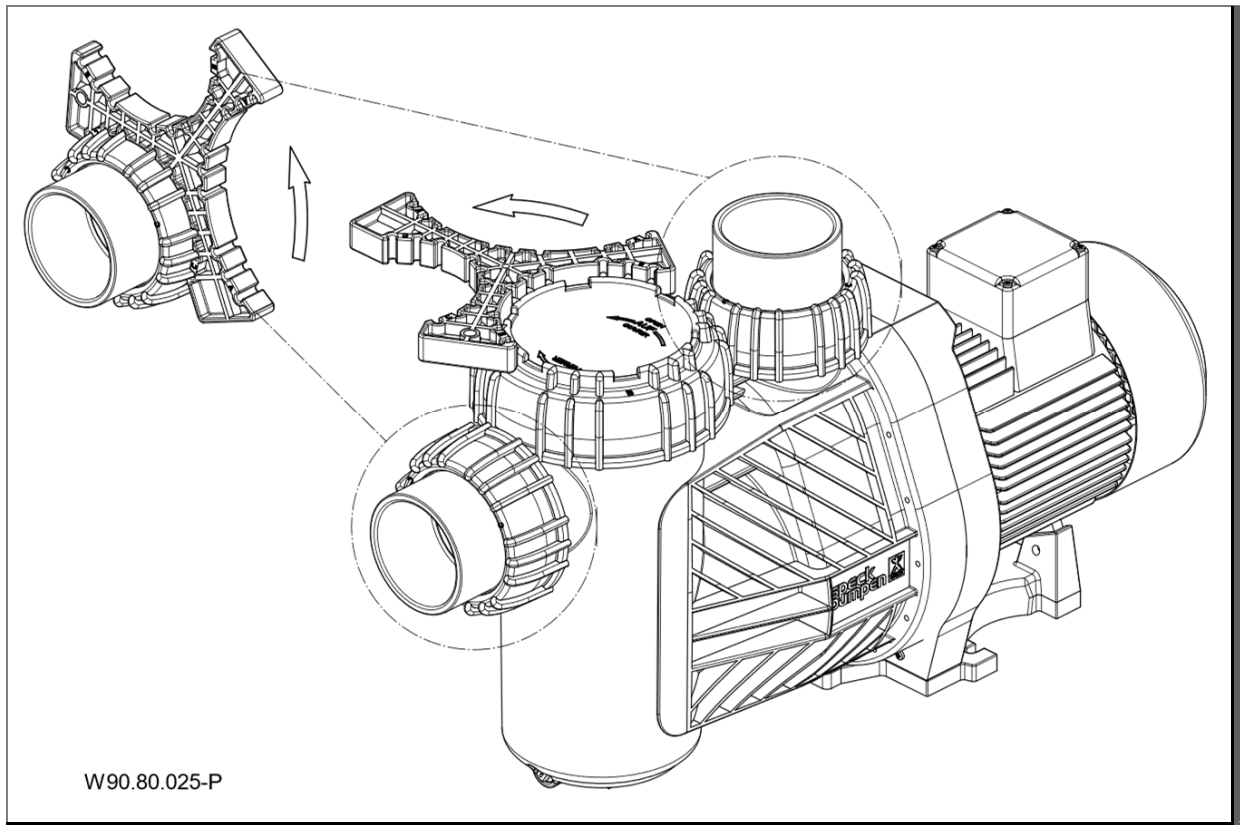

EG-Konformitätserklärung

EC declaration of conformity | Déclaration CE de conformité | EG-verklaring van overeenstemming | Dichiarazione CE di conformità | Declaración de conformidad

Hiermit erklären wir, dass das Pumpenaggregat/Maschine

Hereby we declare that the pump unit | Par la présente, nous déclarons que l'agrégat moteur-pompe | Hiermee verklaren wij, dat het pompaggregat | Con la presente si dichiara, che la il gruppo pompa/la macchina | Por la presente declaramos que la unidad de bomba

Baureihe

Series | Série | Serie | Serie | Serie

BADU Eco Flex

folgenden einschlägigen Bestimmungen entspricht:

is in accordance with the following standards: | correspond aux dispositions pertinentes suivantes: | in de door ons geleverde uitvoering voldoet aan de eisen van de in het vervolg genoemde bepalingen: | è conforme alle sequenti disposizioni pertinenti: | cumple las siguientes disposiciones pertinentes:

EG-Maschinenrichtlinie 2006/42/EG

EC-Machine directive 2006/42/EC | CE-Directives européennes 2006/42/CE | EG-Machinerichtlijn 2006/42/EG | CE-Direttiva Macchine 2006/42/CE | direttiva europea de maquinaria 2006/42/CE

EMV-Richtlinie 2014/30/EU

EMC-Machine directive 2014/30/EU | Directives CE sur la compatibilité électromagnétique 2014/30/UE | Richtlijn 2014/30/EU | Direttiva di compatibilità elettromagnetica 2014/30/EU | direttiva 2014/30/UE

EG-Richtlinie 2012/19/EG (WEEE)

Directive 2012/19/EC (WEEE) | Directive CE 2012/19 (DEEE) | EG-Richtlijn 2012/19/EG (WEEE) | Direttiva 2012/19/CE (WEEE) | CE-Directiva 2012/19/EG (tratamiento de residuos de componentes de aparatos eléctricos y electrónicos y electrónicos en desuso)

EG-Richtlinie 2011/65/EG (RoHS)

Directive 2011/65/EC (RoHS) | Directive CE 2011/65 (RoHS) | EG-Richtlijn 2011/65/EG (RoHS) | Direttiva 2011/65/CE (RoHS) | CE-Directiva 2011/65/EG (limitación de utilización de determinados productos peligrosos en aparatos eléctricos y electrónicos y electrónicos)

Ökodesign-Richtlinie 2009/125/EG

Ecodesign Directive 2009/125/EC | Directive d'écoconception 2009/125/CE | Ecodesign-richtlijn 2009/125/EG | Direttiva sulla progettazione ecocompatibile 2009/125/CE | Directiva 2009/125/CE Ecodiseño

Angewendete harmonisierte Normen, insbesondere

According to the provisions of the harmonized standard for pumps in particular | Normes harmonisées appliquées, notamment | Gebruikte geharmoniseerde normen, in het bijzonder | Norme armonizzate applicate in particolare | Normas armonizadas aplicadas, especialmente

EN 60335-1:2012 EN 60335-2-41:2012 EN 61800-3:2012
EN 61000-4-2/3/5/6/11/13/28 EN 61000-3-2:2015 EN ISO 12100



i.V. Sebastian Watolla

Technischer Leiter und Dokumentations-
bevollmächtigter | Technical director and
authorised representative | Directeur technique et
responsable des documentations | Technisch
directeur en documentatie gemachtigde | Direttore
tecnico e autorizzato per la documentazione |
Director técnico y documentación autorizada

91233 Neunkirchen am Sand, 04.09.2020



Armin Herger

Geschäftsführer | Managing Director |
Gérant | Bedrijfsleider |
Amministratore | Gerente

SPECK X
pumpen

SPECK Pumpen Verkaufsgesellschaft GmbH
Hauptstraße 3, 91233 Neunkirchen am Sand, Germany